

Co-funded by the
Erasmus+ Programme
of the European Union



Module 6

CT for informatics (computing) prospective teachers: specific features, approaches and practical solutions

Authors: Vienna University of Technology (Austria)

Gerald Futschek
Philipp Prinzinger
Merve Sen
Ulrike Schäfer
Matthias Rausch
Franziska Tiefenthaller
Martina Landman

Reviewers:

Claudia Tenberge (UPB), Vaida Masiulionytė-Dagienė (VU)

External reviewers:

Piret Luik (Estonia), Jos Tolboom (Netherlands)

Design (icons):

Vaidotas Kinčius (Lithuania)

Piloting:











Vienna University of Technology (Austria), Vilnius University (Lithuania)

Module *outline* is based on the work within the project “Future Teachers Education: Computational Thinking and STEAM” (TeaEdu4CT). Coordination: Prof. Valentina Dagienė, Vilnius University, Lithuania. Partners: Vienna University of Technology (Austria), CARDET (Cyprus), Tallinn University (Estonia), University of Turku (Finland), Paderborn University (Germany), CESIE (Italy), Radboud University (Netherlands), KTH Royal Institute of Technology (Sweden), Ankara University (Turkey). The project has received co-funding by the Erasmus+ Programme KA2.

TeaEdu4CT project (grant no. 2019-1-LT01-KA203-060767) 2019 license granted.



Content

| | | |
|---|--|----|
|  | General overview and aim | 3 |
|  | Target group and prerequisites | 3 |
|  | Learning Outcomes (LOs) and Assessment Methods | 4 |
|  | Module plan and didactical approaches | 5 |
|  | Units and activities | 7 |
|  | Learning resources | 29 |
|  | Granularity | 31 |
|  | References | 31 |
|  | Additional resources | 32 |
|  | Appendix 1: Material for students - future teachers | 32 |
|  | Appendix 2: Material for school teachers to be used in class | 34 |
| | Unit 1. CT demonstrated on the algorithmic paradigm divide-and-conquer | 35 |
| | Unit 2. CT aspects of codes | 57 |
| | Unit 3. CT aspects of computer simulations | 73 |
| | Unit 4. Robotics and sensor technology: CT in our digital world | 90 |





General overview and aim

Informatics serves as a general method to develop problem solving processes and to present them in an exact formalism in such a way that the concrete determination of solutions can be directly transferred to a technical solution. The thought processes in this problem solving process are defined as Computational Thinking. In general, one can say that Computational Thinking is a problem solving ability. For more information on Computational Thinking, please refer to Module 2.

Since the target group of the learning material developed in this module are prospective informatics teachers, all content is related to informatics:

Unit 1: CT demonstrated on the algorithmic paradigm divide-and-conquer

Unit 2: CT aspects of codes, understanding Huffman codes

Unit 3: Virus simulation: CT in biology, medical research, and health

Unit 4: Robotics and sensor technology: CT in our digital world

The first two units deal with core informatics topics obtained from algorithms and information representation. Two further units deal with interdisciplinary problem solving with means of informatics. The interdisciplinary activities are “inquiries which critically draw upon two or more disciplines and which lead to an integration of disciplinary insights” (Haynes, 2002, cited in Jones, 2010, p. 17).

We relate the classification of Computational Thinking skills to (Dagiene, Sentance, 2016, p. 30f) who use the following skills: abstraction, algorithmic thinking, decomposition, evaluation, and generalisation.

Based on concrete tasks, the form in which CT is used in the developed solution strategies is analysed. In addition to the occurrence of CT, emphasis is placed on the concrete relation to the respective discipline.

The three main objectives of this module are:

- To apply CT skills to different tasks
- To show where CT occurs and in what ways
- To identify technical references of CT to various disciplines



Target group and prerequisites

The target group consists of informatics teacher educators in tertiary education and their prospective informatics teachers.

Requirements

Required pre-knowledge of prospective informatics teachers:

- Knowledge of Computational Thinking Skills (Abstraction, Decomposition, Generalisation, Evaluation, Algorithmic Thinking).
- Initial programming skills.
- Basic knowledge of algorithms and data structures.

Keywords

Unit 1: divide-and-conquer, decomposition, algorithm, algorithmic thinking, parallelisation, recursion

Unit 2: binary codes, fixed-length, variable-length, minimal code length, Huffman code

Unit 3: virus simulation, disease spread, virology

Unit 4: robotics, sensor technology, micro controller

Related competence frameworks

The contents of this module promote the following competences of the DigCompEdu competence model (Redecker, 2017, p. 24f):

- 3.1 Teaching:** In order to show CT aspects in computer science to future teachers, tasks have to be done in different programming languages and with different digital tools.
- 3.3 Collaborative learning:** This is largely achieved through group work in both face-to-face teaching and home exercises. In these exercises, the future teachers are allowed and encouraged to exchange information, give feedback and discuss different views.
- 5.1 Accessibility & inclusion:** work in progress
- 5.2 Differentiation & personalisation:** The open-ended tasks offer a variety of solutions, so all participants can work on their levels and find adequate solutions.
- 5.3 Actively engaging learners:** Through the open-ended tasks that offer creative freedom, future teachers can actively participate and implement their ideas.
- 6.3 Content creation:** In each unit, the future teachers have to create digital content. They have to create programs in different programming languages and present their outcomes digitally.
- 6.5 Problem solving:** CT is dealing with problem solving. Most of the tasks of this module start with a given problem that should be solved by the prospective teachers.



Learning Outcomes (LOs) and Assessment Methods

A successful learner (prospective teacher) is able to:

- understand the power and versatility of CT in informatics and in other disciplines;
- be able to apply CT to problem solving in informatics contexts;
- have knowledge of CT skills and their meanings to analyse their relevance for specific problems;
- develop problem solving skills to create individual solutions.

Assessment methods:

- Assessment of the homework
- Assessment of active participation in the activities and discussions



Module plan and didactical approaches

This module consists of **4 units** à 4 sessions à 45 minutes. The first two units deal with computer science related topics, and the other two modules deal with interdisciplinary topics such as virus simulation and robotics. The units are structured differently, some consist mainly of activities to be solved in groups and some of projects to be completed and presented by prospective teachers.

ECTS Breakdown

| Unit | Teaching | Homework | Total |
|----------------|----------|----------|-----------------------------|
| Unit 1 | 180 min | 190 min | 370 min = 6 h 10 min |
| Unit 2 | 180 min | 190 min | 370 min = 6 h 10 min |
| Unit 3 | 180 min | 225 min | 405 min = 6 h 45 min |
| Unit 4 | 180 min | 195 min | 375min = 6 h 15 min |
| Modul 6 | | | 25 h 20 min ≈ 1 ECTS |

Didactical approach

Since CT is a problem solving skill, our didactical approach is based on gaining experience in problem solving using CT and in reflecting the involved thought processes. It is a very practical approach with nearly no theoretical input. It is a learner centered approach and often constructive in building artefacts. It can be called inquiry-based learning inspired by constructionism.

The topics of the four units:

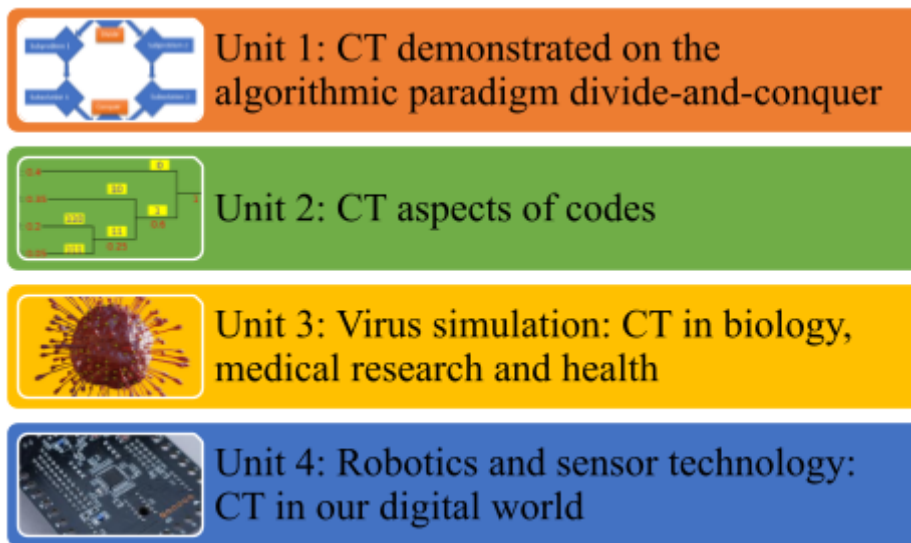
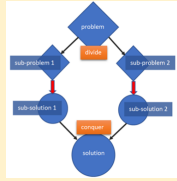

Fig. 1: Overview of the four units' topics

Further details can be found in the documents for the respective units.



Units and activities



Unit 1: CT demonstrated on the algorithmic paradigm divide-and-conquer

Brief description

Unit 1 consists of 2 parts. Both parts consist of 2 sessions á 45 minutes.

- The **first part (Activity 1.1)** refers to the divide-and-conquer technique (D&C). The concept of divide-and-conquer is introduced through several unplugged activities, which are carried out in small groups, related to CT and discussed in plenary.
- The **second part (Activity 1.2)** focuses on recursion in relation to the divide-and-conquer technique and the possible thought patterns that may be required in this approach.

Detailed description

The detailed planning of the unit and links to additional resources can be found in [TeaEdu4CT_Modul6_Unit1.pdf](#).

A detailed description of the activities can be found in [Unit1_DivideConquer_Activities.pdf](#)

Overview of Activity 1.1:

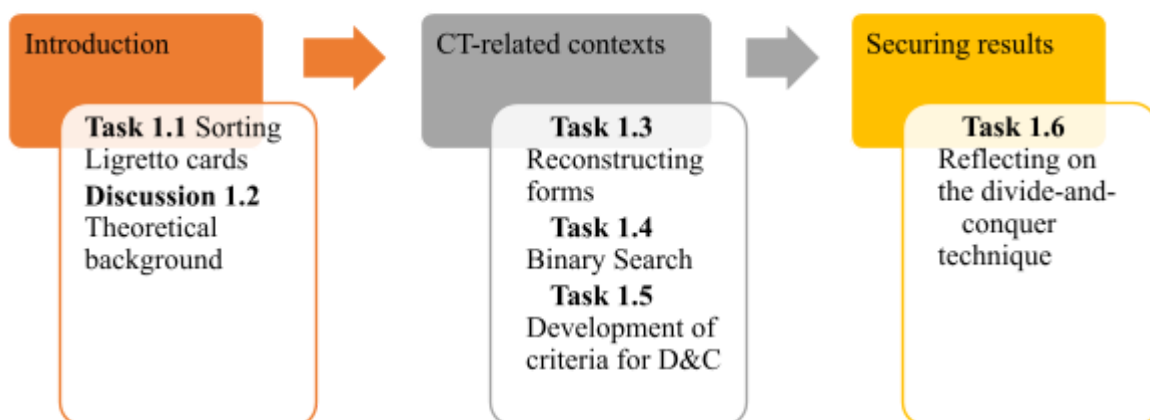

Fig. 2: Overview of Activity 1.1

Introduction

Task 1.1: Ligretto cards



Duration: 10 minutes



Group work

- This is a "warm-up" activity. A set of Ligretto cards is provided for each group of up to 8 students.
- The intention is to introduce prospective informatics teachers to the basic thought processes of the divide-and-conquer technique.
- The teacher educator briefly explains the goal of the task and gives the prospective teachers a few minutes to think of a strategy to sort the cards as a team. Afterwards the first round starts.
- The motivation for a group is to sort faster than the other groups. The goal is to deliver a correctly sorted deck of cards in the middle of the group table.
- After that, the groups should exchange their ideas for a few minutes, and then the second round starts.
- Usually, all groups improved their strategies and performed the task faster in the second round.

Discussion 1.2: Informatics context of Task 1.1



Duration: 5 minutes



Plenum

- After Task 1.1, the teacher educator refers to the relation of this task to informatics: parallelisation, multi-core processors in smartphones, fast performance. The teacher educator discusses the principle of division of tasks and parallelisation for faster problem solving with the prospective teachers.

CT-related contexts

Task 1.3: Reconstructing 3d-patterns



Duration: 10 - 15 minutes



Group work



Unit1_DivideConquer_Activities.pdf, p. 5

- The intention here is that the fundamental processes of divide-and-conquer, which were already introduced in Task 1.1, are used to solve hands-on tasks. Via pattern recognition and decomposition, given 3d-patterns should be reconstructed in a group efficiently.
- Deepening of what has been learned.

Task 1.4: Binary Search: A special case of D&C

Duration: 10 - 15 minutes



Group work



Unit1_DivideConquer_Activities.pdf, p. 7

- This task provides a special case of D&C, where only one part of the division is further inspected for determining the result.
- Deepening of what has been learned.

Task 1.5: Find criteria for D&C

Duration: 25 - 30 minutes



Group work



Unit1_Examples_D_C.pdf

- This is a task for a better understanding of the divide-and-conquer technique.
- Which problems can be solved with D&C, which not?
- The intention is to identify under which conditions the CT technique D&C can be applied using daily life examples.
- Process:
 - In small groups (3-4 students), students should find criteria for which kinds of problems divide-and-conquer can be applied, based on the previous tasks.
 - These criteria should be entered in a Word Cloud (Mentimeter. <https://www.mentimeter.com/app>).
 - Based on these criteria, the daily life examples (Unit1_Examples_D_C.pdf) are to be analysed in small groups.
 - Afterwards, there is a discussion about the results.
- Prospective teachers reflect on the criteria of the word cloud.

Securing results**Task 1.6: Reflecting on the divide-and-conquer technique**

Duration: 10 - 15 minutes



Individual work

- This is a task to recall the essential points.
- The intention is to deepen and consolidate the content that has been worked out.
- Prospective teachers reflect on questions and statements regarding D&C. They also should evaluate the criteria for the applicability of the divide-and-conquer technique.



Homework assignment



Duration: 90 minutes



Homework

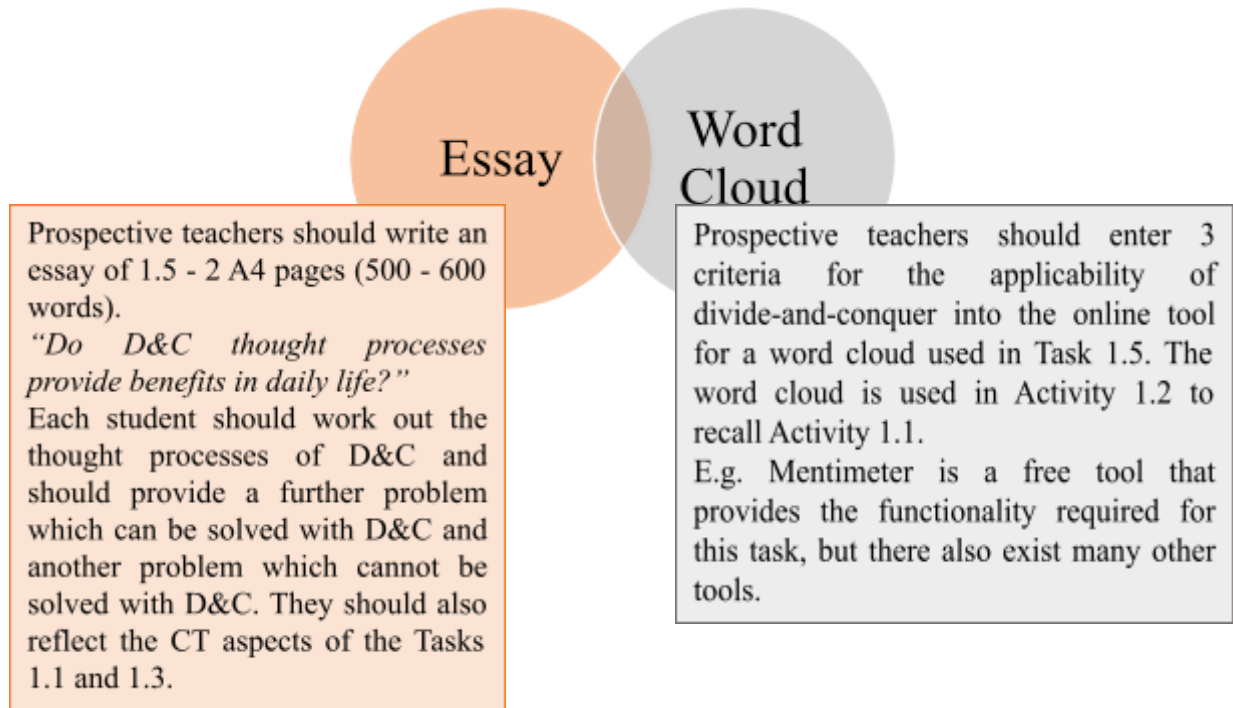

Overview of Activity 1.2:

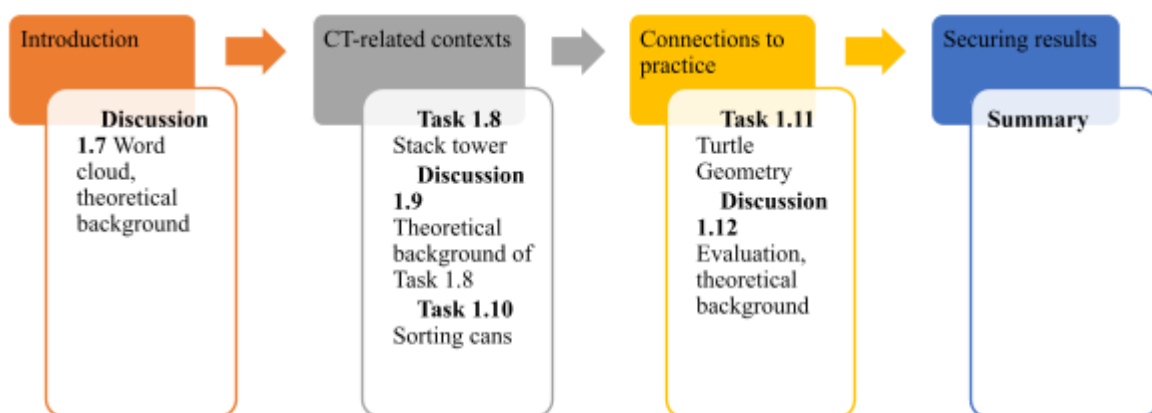

Fig. 3: Overview of Activity 1.2

Introduction

Discussion 1.7: Analysing the word cloud



Duration: 10 minutes



Plenum

- To warm up the audience and repeat Activity 1.1, the teacher educator presents the word cloud of the last homework.
- Prospective teachers have the opportunity to share their thoughts on the chosen criteria.

CT-related contexts

Task 1.8: Stack Tower



Duration: 20 minutes



Group work

- The intention is to introduce prospective teachers to problem solving by recursion.
- At least two groups are formed, each solves the stack tower task: build a tower of the (sorted) nested boxes, shown in fig. 4.
- Each group should provide written instructions on how to reach the solution step by step.
- The instructions are exchanged between the groups.
- The respective peer group should build the tower, following the written instructions. They can also add possible improvements and give feedback.

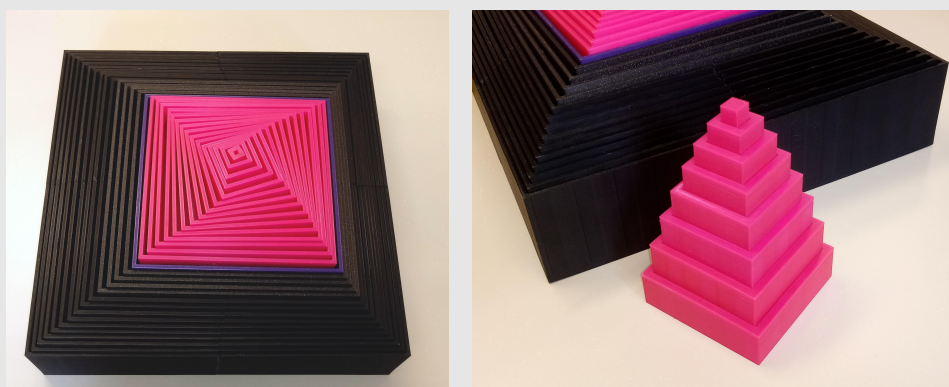

Fig. 4: Left: The nested boxes of the stack tower; right: A part-tower build of a subset of the nested boxes.

Discussion 1.9: Recursion as a special case of D&C



Duration: 5 minutes



Plenum

- Brainstorming about the specific issues of the thought processes of recursive application of D&C.

Task 1.10: Sorting cans



Duration: 15-20 minutes



Group work



Unit1_DivideConquer_Activities.pdf

- Prospective teachers are confronted with a large number of equally sized cans of different weights. The weight of the cans is not visible from the outside.
- For comparing the weight of two cans the prospective teachers are provided with a balance scale or provisionally with a pencil and a ruler.
- The prospective teachers have to find an algorithm to sort the cans ascending (or descending) by weight as quickly as possible.
- The teacher educator encourages the prospective teachers to use the D&C technique to improve the time efficiency of the sorting process.
- The prospective teachers should describe the algorithms in pseudocode.
- The different algorithms are analysed, compared and their efficiency is discussed.

Connections to practice

Task 1.11: Turtle geometry



Duration: 20-25 minutes



Plenum



Unit1_TurtleGeometry.pdf

- The teacher educator presents the prospective teachers a picture of a snowflake drawn by a recursive turtle geometry program.
- The prospective teachers should discuss the recursive structure of the picture.
- If necessary, they are introduced to Scratch and turtle geometry by the teacher educator.
- The teacher educator solves the problem step by step in collaboration with the prospective teachers.

Discussion 1.12: Evaluate Task 1.11



Duration: 5-10 minutes



Plenum

- The possible thought patterns used to draw the turtle geometry picture are discussed in the plenum.
- The quality of Task 1.8, Task 1.10 and Task 1.11 for teaching CT and recursion, in particular, is discussed in the plenum.

- Criteria for good tasks for understanding recursion are discussed in the plenum.

Securing results

Presentation 1.13: D&C's main points



Duration: 5 minutes



Frontal teaching

- A summary is provided by the teacher educator.
- The most important thought patterns in solving divide-and-conquer problems by recursion are repeated.
- The suitability of tasks for teaching the divide-and-conquer technique is discussed.

Homework assignment



Duration: 100 minutes



Homework

Creating
a task

Design
of a
sample
solution

A specification of a rather
divide-and-conquer task
should be created.

A sample solution of the task
should be given. Possible ways of
thinking to solve the task
should be explored and described.

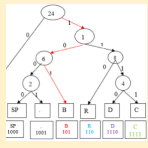

Unit 2: CT aspects of codes

Brief description

Unit 2 consists of 2 parts. Both parts consist of 2 sessions à 45 minutes.

- In the **first part**, brainstorming is initially carried out so that the current knowledge of prospective teachers can be accessed and built upon. Afterwards the first activities start.
- In the **second part** the knowledge is deepened with further activities. In this unit Bebras tasks are integrated.

This unit focuses briefly on the informatics concepts of data representation and the key CT thinking skills abstraction and evaluation.

Overview of Unit 2.1:

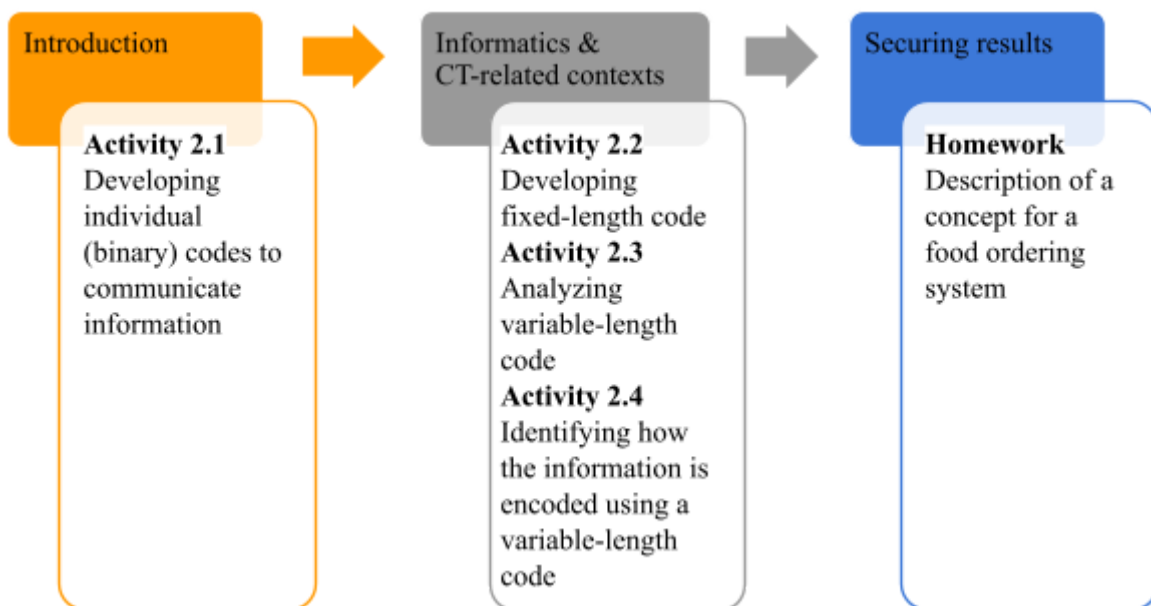

Fig. 5: Overview of unit 2.1

Introduction

Activity 2.1: Developing individual (binary) codes



Duration: 30 minutes



Plenum



Unit2_Activity_2.1_CreatingCodes.pdf

Introduction to codes and communication through codes

- 1) Create a code for five given messages
- 2) Create a binary code for the five messages of 1)
- 3) Create a binary code to transmit any messages

Informatics & CT-related contexts

Activity 2.2: Ice Cream Shop 1 (Code with fixed word length)



Duration: 15 minutes



Group work



Unit2_Activity_2.2_IceShop1.pdf

- Introductory activity to fixed-length binary codes.
- In this activity, the prospective teachers should solve a series of scaffolded tasks (Unit2_Activity_2.2_IceShop1.pdf) to fixed-length codes.
- The required minimum code length of a fixed-length code for a given set of elements should be determined.
- Characteristics of fixed-length codes should be analysed.

Activity 2.3: Fireworks



Duration: 15 minutes



Individual work



Unit2_Activity_2.3_Fireworks

- This activity is the Bebras-task “Fireworks” from 2015.
- The core of this task is to recognize the problem of possible ambiguity in variable-length code.
- Prospective teachers should recognize that some code sequences have more than one meaning.
- The prospective teachers should determine characteristics of variable-length codes regarding uniqueness, respectively ambiguity.

Activity 2.4: Code split



Duration: 25 minutes



Individual work



Plenum



Unit2_Activity_2.4_SplitTheCode.pdf

- In the given task sheet Unit2_Activity_2.4_SplitTheCode.docx the prospective

informatics teachers should a) break a given prefix code and b) create their own binary variable-length prefix code.

- After completing the tasks, the solutions and results are discussed in plenary. Basis of the discussion are at least three different solutions of created variable-length codes should be presented by the prospective informatics teachers.
- To bring everything in context and summarize it, the graphic regarding subject content, IT content and CT skills (taken from module 2) should be filled out in plenum.

Securing results

Homework assignment



Duration: 5 minutes



Plenum

By conceptual development of an ordering system for fast food, the informatics and CT aspects regarding codes should be worked out and described.

Homework assignment



Duration: 90 minutes



Homework



Individual work



Unit2_Homework_2a_FoodOrderingSystem.pdf

Components and CT aspects of a food ordering system

By conceptual development of an ordering system for fast food, the informatics and CT aspects regarding codes should be worked out and described.

The problem-solution graphic (taken from module 2) should be filled out, and the occurring CT skills should be described in the table below.

Overview of Unit 2.2:

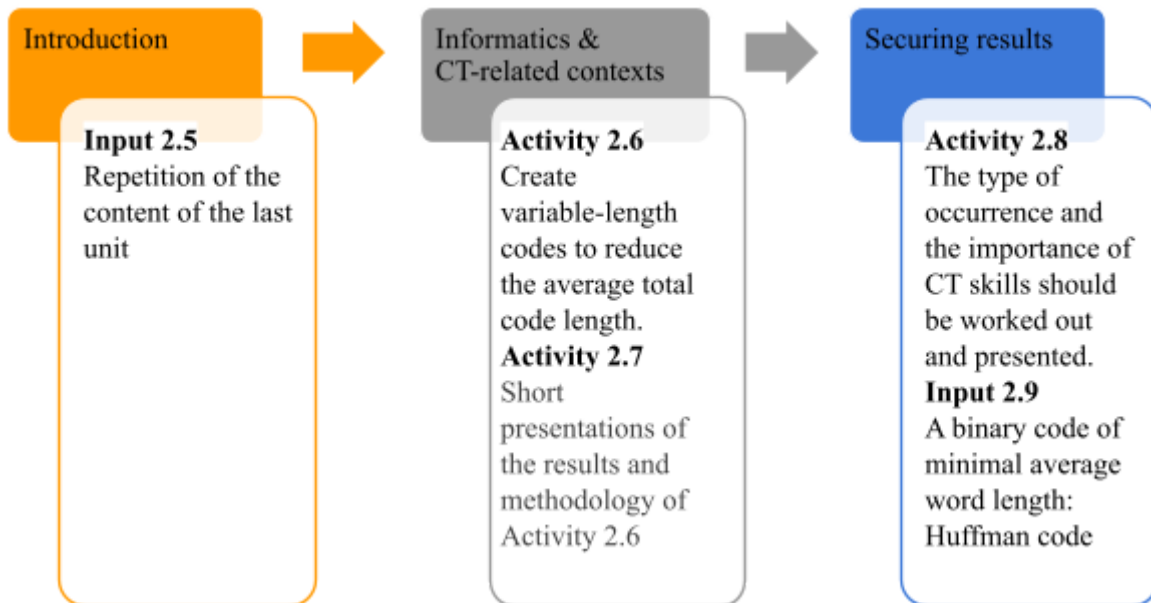

Fig. 5: Overview of Unit 2.2

Introduction

Input 2.5: Short repetition and elaboration



Duration: 5 minutes



Plenum

- The last unit should be repeated briefly so that everyone is up to date.

Informatics & CT-related contexts

Activity 2.6: Ice Cream Shop 2



Duration: 15 minutes



Group work



Unit2_Activity_2.6_IceShop2.pdf

- Continuation of Ice Cream Shop 1.
- Now the prospective teachers can encode words using variable-length code.
- Prospective teachers can now work in groups. They are to solve the work assignment in small groups, after which the results and findings are discussed with the whole class.

Activity 2.7 Presentations of the results of Activity 2.6

Duration: 25 minutes



Group work

- In short presentations, the results of Activity 2.6 shall be presented and discussed.
- In the discussions, the differences between the results shall be pointed out, and possible optimisations elaborated.

Securing results**Activity 2.8: CT chart**

Duration: 20 minutes



Expert Discussion

The activity will be carried out in three phases:

- 1) Individual phase (5 min): Each group member specializes in one CT skill. The characteristics of each CT skill should be described and the importance of each skill in terms of codes should be indicated on a discrete scale. The scale goes from 0 to 5, with 5 being the highest and 0 the lowest importance.
- 2) Discussion in the group (5 min): After all group members have individually dealt with a CT skill, they should exchange their insights. At the end of the discussion, all groups have a score for each CT skill and can describe the way it occurs.
- 3) Plenum discussion (5 min): At the beginning of the plenum discussion the CT chart is made up of all the rating strips. Thereby similarities and differences become visible. Depending on the time available, the CT chart and the different scores can be discussed.

Input 2.9: A binary code of minimal average word length: Huffman code

Duration: 20 minutes



Frontal teaching



Unit2_HuffmanCode.pdf

- Brief lecture on Huffman code.

Homework assignment

Duration: 5 minutes



Frontal teaching

- Prospective informatics teachers should create a new bebras task about codes.



Homework assignment



Duration: ~100 minutes



Homework

Creating a new task

Prospective informatics teachers should create a new bebras task about Coding with CT-Background. They should describe the relation of the task to computer science and the CT skills involved in the task.

Detailed Description

The detailed planning of the unit can be found in [TeaEdu4CT_Modul6_Unit2.pdf](#).

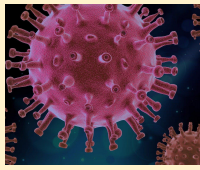

Unit 3: Virus simulation: CT in biology, medical research and health

Brief description

This is one of two units that focus on interdisciplinary aspects of CT. The focus of this unit is to outline the occurrence of CT skills regarding simulations on the example of a simulation of virus epidemics. For this purpose, the prospective informatics teachers develop a simulation of a viral disease using Starlogo TNG. The prospective informatics teachers should write a work documentation of the whole work of Unit 3, including homework.

Although there is programming involved, the main focus lies on the CT skills and their occurrence in the whole development process of programming a virus simulation.

Overview of Unit 3.1:

This double session (90 min) includes research on viral diseases from a biological and medical perspective, the occurrence of CT skills in simulations using a concrete example, and an introduction to StarLogo TNG.

There are also two homeworks included, one before the double session and one after.

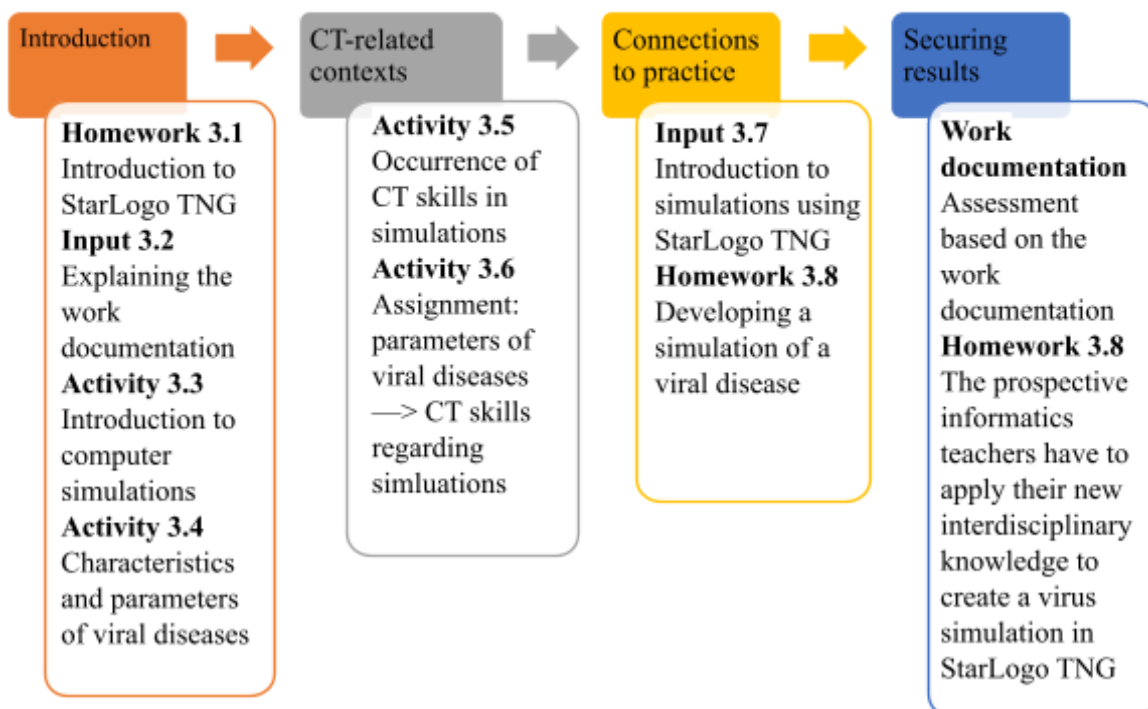

Fig. 6: Overview of Unit 3.1

Introduction

Homework 3.1: Introduction to StarLogo TNG



Duration: 60 minutes



Individual work



Homework



Unit3_Homework_3.1_IntroductionToStarLogoTNG.pdf

- Getting familiar with the programming language and development environment through a series of tasks and tutorials

Input 3.2: Work documentation



Duration: 5 minutes



Plenum



Frontal teaching

- Presenting the template for the work documentation and how the work should be reported.
- Explaining how the work documentation will be assessed.

Activity 3.3: Introduction to computer simulations



Duration: 15 minutes



Group work

- Based on an example of a computer simulation, the key aspects of computer simulations are determined.

Activity 3.4: Characteristics and parameters of viral diseases



Duration: 10 minutes



Group work



Unit3_ibc-health-common-position-paper-eng.pdf

- Searching for information about viral diseases
- Determination of characteristics of viral diseases

CT-related contexts

Activity 3.5: CT skills regarding computer simulations



Duration: 5 minutes



Group work

- Based on an example presented in Activity 3.3, the occurring CT skills and informatics concepts are determined and described using the two-dimensional categorisation system from Dagienė, Sentance and Stupurienė (2017).

Activity 3.6: Assigning parameters of viral diseases to CT skills and informatics concepts



Duration: 10 minutes



Group work

- The prospective informatics teachers shall describe the correlation between the parameters of viral diseases and CT skills for a computer simulation using a two-dimensional matrix.

Connections to practice

Input 3.7: Introduction to simulations using StarLogo TNG



Duration: 30 minutes



Plenum



Frontal teaching

- Presenting the fundamentals to create a multi-agent simulation with StarLogo TNG
- Discussing questions from homework 3.1
- Explaining Homework 3.8

Homework 3.8: Virus simulation in StarLogo TNG



Duration: 120 minutes



Homework



Group work



Unit3_Homework_3.8_Tasks_VirusSimulation.pdf

- Development of a virus simulation in StarLogo TNG via a set of scaffolded tasks.

Securing results

Work documentation

The work documentation should help to secure results by repeating and reflecting on work processes and findings.

Giving insights into the work and thought processes of the prospective informatics teachers.



Unit3_WorkDocumentation_Template.pdf

Homework 3.8

The application of the found characteristics by creating a virus simulation in StarLogo TNG and their correlation to CT skills should generate practical relevance and thus deepen the knowledge.

Homework assignment



Duration: 180 minutes



Individual work



Group work



Homework

Introduction
to StarLogo
TNG

Programming
a virus
simulation

In the preparation for Unit 3, the prospective informatics teachers are given a series of tasks and links to tutorials for StarLogo TNG. In this type of flipped classroom setting, they are familiarized with the programmings language and development environment.

Development of a virus simulation in starLogo TNG via a set of scaffolded tasks. The individual outcomes should include the characteristics found. In their implementations the correlating CT skills should be considered and applied.

Overview of Unit 3.2:

The second double session (90 min) of this unit focuses on the developed virus simulations and their evaluation. The simulations should be finalized and presented. The presentations are followed by discussions on the implemented parameters of viral diseases and the influence of CT skills on the development.

Regarding the developed simulations and the interdisciplinary content of this topic, research questions and findings should be formulated.

To summarize and secure results, the two-dimensional assignment matrices are presented and refinements and revisions to the simulations are discussed.

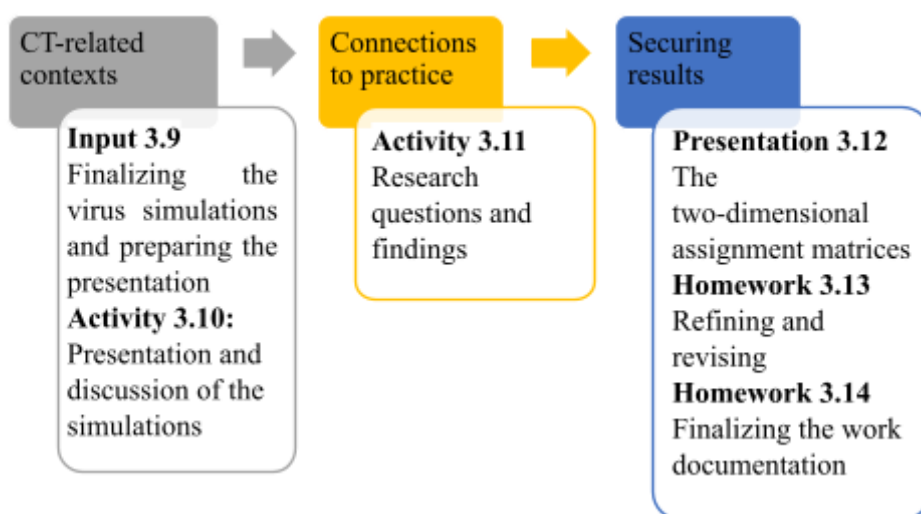







Fig. 7: Overview of unit 3.2

| CT-related contexts | | |
|--|----------------------|---|
| Activity 3.9: Finalizing the virus simulations and preparing the presentation | | |
|  | Duration: 20 minutes |  Group work |
| <ul style="list-style-type: none"> • Finishing of the development of the virus simulation. • Preparing the presentation of the virus simulation including informatics, biological, medical and health findings. | | |
| Activity 3.10: Presentation and discussion of the simulations | | |
|  | Duration: 45 minutes |  Plenum  Group work |
| <ul style="list-style-type: none"> • Short presentations (about 3 - 5 mins) from each group. • Brief discussion about viral disease characteristics (subject content), CT skills and informatics concepts (IT content) after every presentation. | | |

Connections to practice

Activity 3.11: Research questions and finding



Duration: 10 minutes



Plenum



Group work

- Formulating informatics, biological, medical and/or health research questions.
- Describing informatics, biological, medical and/or health findings.

Securing results

Presentation 3.12: The two-dimensional assignment matrices



Duration: 10 minutes



Plenum



Group work

- Presentation and summary of the two-dimensional assignment matrices.

Homework 3.13: Refining and revising the simulations



Duration: 15 minutes



Individual work



Homework

- Every single prospective informatics teacher should refine and maybe revise their simulation developed in group work due to the presentations, discussions and reflections.

Homework 3.14: Finalizing the work documentation



Duration: 30 minutes



Individual work



Homework

- Completing and finalizing the work documentation.

Homework assignment



Duration: 45 minutes



Homework



Individual work

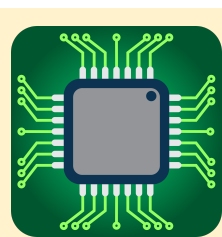
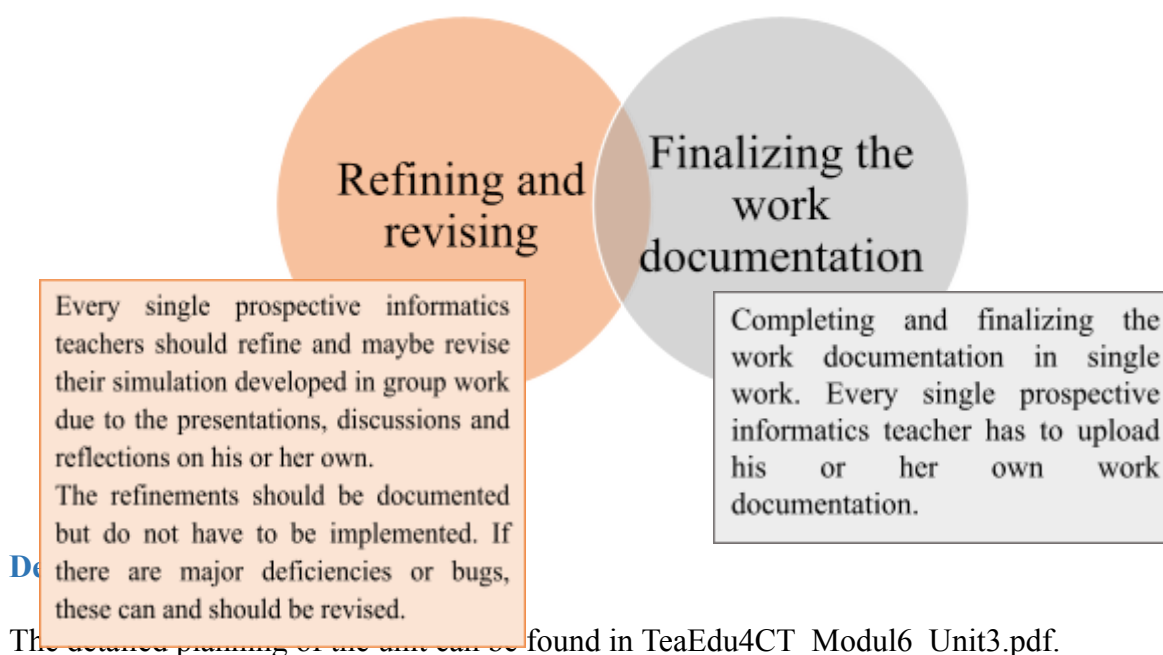

Unit 4: Robotics and sensor technology: CT in our digital world

Brief description

This unit is one of two units which focus on interdisciplinary aspects of CT. In this module we deal with robotics and sensor technology.

In the **first session** the CT skills will be worked out by showing a video about the implementation of a project with a microcontroller. Afterwards, the prospective teachers will work in small groups on a project to solve the problem:

What can be done to reduce heat sources in urban areas?

and implement it.

Afterwards, the project results, including the CT skills used, will be presented and discussed.

Overview

This unit comprises four sessions of 45 minutes each. The four sessions can either take place on 4 different dates as individual lessons or on two different dates with a double session of 90 minutes each. However, this unit cannot be held as a single block course on a single day because the prospective teachers have to design and implement projects as homework, which will be presented at the end of this unit.

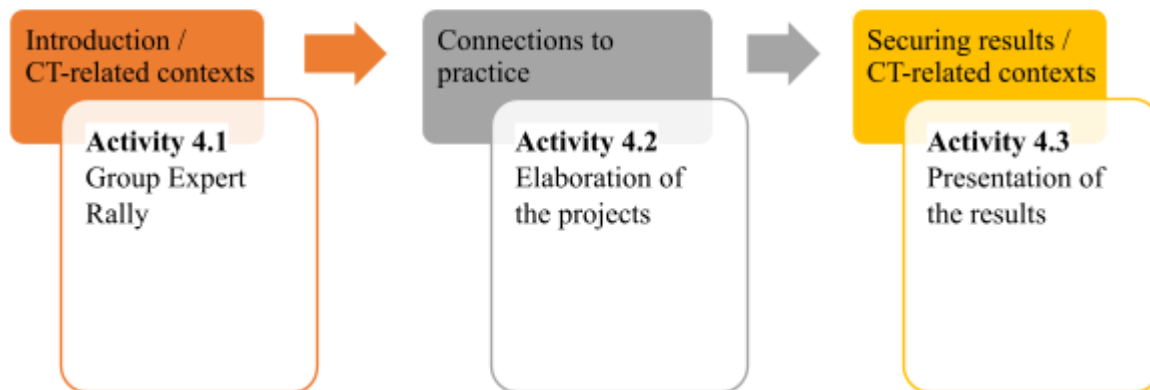

Fig. 8: Overview of Unit 4

Introduction / CT-related contexts

Activity 4.1: Group Expert Rally (Session 1)



Duration: 45 minutes



Group Expert Rally



Video: Science Experiments 03 Temperature Sensor

<https://www.youtube.com/watch?v=pHDYsy6xyE4>

- Getting familiar with the programming language and development environment through a series of tasks and tutorials.
- This is a "warm-up" activity.
- The intention is to work out the CT skills right at the beginning of the unit by showing an example project (video), because they have to consider it later in their own projects as well.
- Process:
 - Grouping
 - Demonstration of a video concerning a microcontroller (micro:bit)
 - Internal discussion in the own group and evaluation of the relevance
 - Based on the evaluation of the CT skills by the groups, a discussion with the whole class takes place

Connections to practice

Activity 4.2 Elaboration of the projects (Session 2, 3)



Duration: ~75 minutes



Group work



Unit4_Project_ClimateChange.pdf

- This is the main work.
- Prospective teachers should consider and implement a project concerning the question
"What can be done to reduce heat sources in urban areas?"
- As a support, the teacher educator will present an example project concerning the above mentioned question (see example Unit4 Project ClimateChange.pdf)

Securing results / CT-related contexts

Activity 4.3 Presentation of the results (Session 3, 4)



Duration: ~75 minutes



Group presentations

- This is for summary and discussion of findings of the prospective teachers.
- At the end of the unit the results are presented and discussed:
 - Explanation topic
 - CT-skills that have been used (using the diagram "conceptualisation" of module 2)
 - Results
 - Project schedule
- The intention here is that the prospective teachers themselves use the microcontroller to gain findings regarding the implementation of a project and reflect on the CT skills that are used during the project.

Homework assignment



Duration: about 195 minutes



Homework

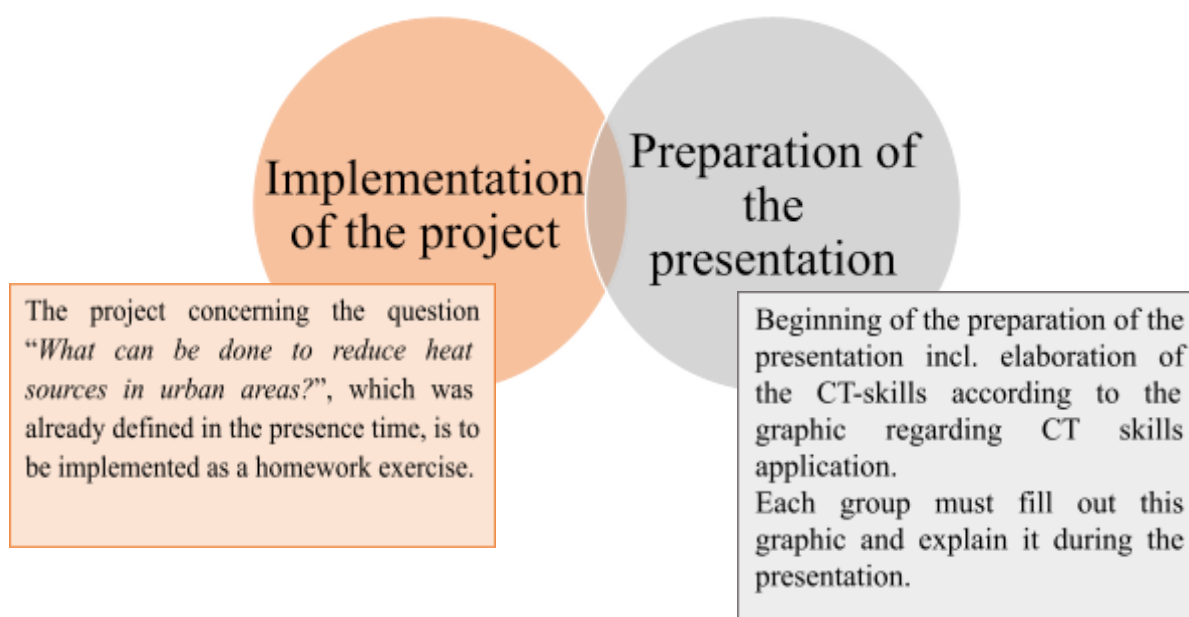

Detailed Description

The detailed planning of the unit can be found in TeaEdu4CT_Modul6_Unit4.pdf.



Learning resources

Unit 1:



- Detailed descriptions of the activities; Unit1_DivideConquer_Activities.pdf
- Examples with D&C about daily life; Unit1_Examples_D&C.pdf
- Statements, Questions for activity “Securing results”; Unit1_1_SecuringResults.pptx
- Programming task & sample solution of the act. turtle geometry; Unit1_TurtleGeometry.pdf
- Sample solution of the activity sort cans; Unit1_SolutionSortCans.pdf



- Algorithm: Mergesort. <https://www.youtube.com/watch?v=JSceec-wEyw>
- Algorithm: Binary Search. Short description (0:0-2:07) <https://www.youtube.com/watch?v=P3YID7liBug>



- Mentimeter. <https://www.mentimeter.com/app>. For Word Cloud.
- Scratch-Online-Plattform. <https://scratch.mit.edu/>.

Unit 2:



- Task sheet for creating (binary) codes; Unit2_Activity_2.1_CreatingCodes.docx.
- Task sheet regarding fixed-length codes; Unit2_Activity_2.2_IceShop1.docx
- Task sheet from Bebras contest regarding variable-length codes; Unit2_Activity_2.3_Fireworks.docx
- Task sheet from Bebras contest regarding prefix codes; Unit2_Activity_2.4_SplitTheCode.docx
- Task sheet to variable-length codes considering the frequency of symbols to be encoded; Unit2_Activity_2.6_IceShop2.docx

Unit 3:



- WHO publication to viral diseases: Unit3_ibc-health-common-position-paper-eng.pdf, p. 1-3



- YouTube: Simulation of natural selection (10 min) <https://www.youtube.com/watch?v=0ZGbIKd0XrM>
- YouTube: StarLogo TNG - Navigation and Setup Methode: <https://www.youtube.com/watch?v=TsTkJ7eB4X0>
- YouTube: StarLogo TNG - Run-Methode and Movement: <https://www.youtube.com/watch?v=GaLZTkMZNK4>
- YouTube: StarLogo TNG - Collision: <https://www.youtube.com/watch?v=0Ie0LTKcLKU>
- YouTube: StarLogo TNG - Create own procedure: <http://web.mit.edu/mitstep/webdav/How%20to%20Create%20a%20Procedure/How%20to%20Create%20a%20Procedure.pdf>
- YouTube: StarLogo TNG - Create Terrain: <http://web.mit.edu/mitstep/webdav/How%20to%20Edit%20Levels/How%20to%20Edit%20Levels.pdf>



- Download and install Starlogo TNG:
<http://web.mit.edu/mitstep/starlogo-tng/download/index.html>



- Example of the work documentation: Unit3_WorkDocumentation_Example.docx

Unit 4:



- Document for the assessment of CT skills (Introduction);
Unit4_Evaluation_GroupExpertRally.docx



- Example project to show; Unit4_Project_ClimateChange.pdf



- Science Experiments 03 Temperature Sensor
<https://www.youtube.com/watch?v=pHDYsy6xyE4>



Granularity

Learning resources for teacher educators:

- see Learning Resources

Learning resources for future CT teachers:

- see Learning Resources (skip Unit1_SolutionSortCans.pdf)

Learning resources for school students:

- Video, readings, books.
- Algorithm: Mergesort.
<https://www.youtube.com/watch?v=JSceec-wEyw>
- Algorithm: Binary Search. Short description (0:0-2:07)
<https://www.youtube.com/watch?v=P3YID7liBug>



References

Abu-Taieh Evon (2018): “The pillars of lossless compression algorithms a road map and genealogy tree.” *International Journal of Applied Engineering Research*, 13(6), 3296-3414, 3399-3400.

Amer Aly (2006): "Reflections on Bloom's revised taxonomy." *Electronic Journal of Research in Educational Psychology* 4.1, 213-230.

Dagienė Valentina and Sentance Sue (2016): "It's computational thinking! Bebras tasks in the curriculum." In *International Conference on Informatics in Schools: Situation, Evolution, and Perspectives*. Springer, Cham.

Dagienė Valentina, Sentance Sue and Stupurienė Gabrielė (2017): “Developing a two-dimensional categorization system for educational tasks in informatics.” *Informatica*, 28 (1), 23-44.

Imhof Julia (2019): “Leitprogrammartige Unterlagen zur Huffman-Codierung”. ETH, Zürich.

Jones Casey (2010): "Interdisciplinary approach-advantages, disadvantages, and the future benefits of interdisciplinary studies." *Essai* 7.1, 26.

Redecker Christine (2017): “European Framework for the Digital Competence of Educators: DigCompEdu.” Punie Yves (ed). EUR 28775 EN. Publications Office of the European Union, Luxembourg.

<https://www.geeksforgeeks.org/merge-sort/>

https://www.hum.at/images/unterrichtsentwicklung/individualisierung/Unterrichtsplanung_mit_Lerntaxonomien.pdf

<https://gist.github.com/sudomann/bdc8ef90a2f4106be28d62d440a21180>



Additional resources

- In advance of his module, Output 2 should be processed, since Output 2 deals with the basics of Computational Thinking. In this module the knowledge of CT skills are a prerequisite.
- It might be possible to continue with Module 2 "Huffman Code" (O6 - Module 2).
- Fadel Charles, Maya Bialik and Bernie Trilling (2018): *Four-Dimensional Education*.

- Papert Seymour (1993): *Mindstorms: children, computers, and powerful ideas*. 2nd ed. New York: Basic Books.
- Rode, J. A., Weibert, A., Marshall, A., Aal, K., von Rekowski, T., El Mimouni, H., & Booker, J. (2015, September). From computational thinking to computational making. In *Proceedings of the 2015 ACM International Joint Conference on Pervasive and Ubiquitous Computing* (pp. 239-250).
- Adler, R. F., & Kim, H. (2018). Enhancing future K-8 teachers' computational thinking skills through modeling and simulations. *Education and Information Technologies*, 23(4), 1501-1514.
- Plant for the Planet. URL: <https://www.plant-for-the-planet.org/de/informieren/baeume-sind-genial-2>
- Micro:bit Extentions. URL: <https://makecode.microbit.org/extensions>



Appendix 1: Material for students - future teachers

Unit 1:



- Detailed descriptions of the activities; Unit1_DivideConquer_Activities.pdf
- Examples of D&C in daily life; Unit1_Examples_D&C.pdf
- Statements, Questions for activity “Securing results”; Unit1_1_SecuringResults.pptx
- Programming task & sample solution of the act. turtle geometry; Unit1_TurtleGeometry.pdf
- Sample solution of the activity sort cans; Unit1_SolutionSortCans.pdf



- YouTube: introducing merge-sort and quick-sort followed by a comparison of both sorting algorithms
<https://www.youtube.com/watch?v=es2T6KY45cA>

Unit 2:



- Task sheet for creating (binary) codes; Unit2_Activity_2.1_CreatingCodes.docx.
- Task sheet regarding fixed-length codes; Unit2_Activity_2.2_IceShop1.docx
- Task sheet from Bebras contest regarding variable-length codes; Unit2_Activity_2.3_Fireworks.docx
- Task sheet from Bebras contest regarding prefix codes; Unit2_Activity_2.4_SplitTheCode.docx
- Task sheet to variable-length codes considering the frequency of symbols to be encoded; Unit2_Activity_2.6_IceShop2.docx

Unit 3:

- Template for the work documentation: Unit3_WorkDocumentation_Template.docx
- Tasks and references for the introduction in StarLogo TNG: Unit3_Homework_3.1_IntroductionToStarLogoTNG.docx
- Tasks for creating a virus simulation: Unit3_Homework_3.8_Tasks_VirusSimulation.docx

Unit 4:

- Example project to show; Unit4_Project_ClimateChange.pdf



- Science Experiments 03 Temperature Sensor
<https://www.youtube.com/watch?v=pHDYsy6xyE4>



Appendix 2: Material for school teachers to be used in class

Unit 1:

- Detailed descriptions of the activities; Unit1_DivideConquer_Activities.pdf
- Examples with D&C about daily life; Unit1_Examples_D&C.pdf
- Statements, Questions for activity “Securing results”; Unit1_1_SecuringResults.pptx
- Programming task & sample solution of the act. turtle geometry; Unit1_TurtleGeometry.pdf

Unit 2:

Unit 3:



Unit 4:



- Document for the assessment of CT skills (Introduction);
Unit4_Evaluation_GroupExpertRally.docx
- Example project to show; Unit4_Project_ClimateChange.pdf



- Science Experiments 03 Temperature Sensor
<https://www.youtube.com/watch?v=pHDYsy6xyE4>



Unit 1. CT demonstrated on the algorithmic paradigm divide-and-conquer

Module *outline* is based on the work within the project “Future Teachers Education: Computational Thinking and STEAM” (TeaEdu4CT). Coordination: Prof. Valentina Dagienė, Vilnius University, Lithuania. Partners: Vienna University of Technology (Austria), CARDET (Cyprus), Tallinn University (Estonia), University of Turku (Finland), Paderborn University (Germany), CESIE (Italy), Radboud University (Netherlands), KTH Royal Institute of Technology (Sweden), Ankara University (Turkey). The project has received co-funding by the Erasmus+ Programme KA2.

TeaEdu4CT project (grant no. 2019-1-LT01-KA203-060767) 2019 license granted.





General overview and aim

Unit 1 - CT demonstrated on the algorithmic paradigm divide-and-conquer

In this module we apply inquiry-based learning. The idea of this method is that the prospective teachers try out themselves, so they understand the theory behind, thus they retain what they have learned in the long term.

It is also important that the learners at school create their own models. For this reason, the activities are designed in a way that they can also be used at school.

Divide-and-conquer is a problem solving strategy in which a problem is broken down into several sub-problems that can be easier solved than the original problem. This process is called "Divide". From the solutions of the sub-problems the solution of the overall problem is then put together. This process is called "Conquer".

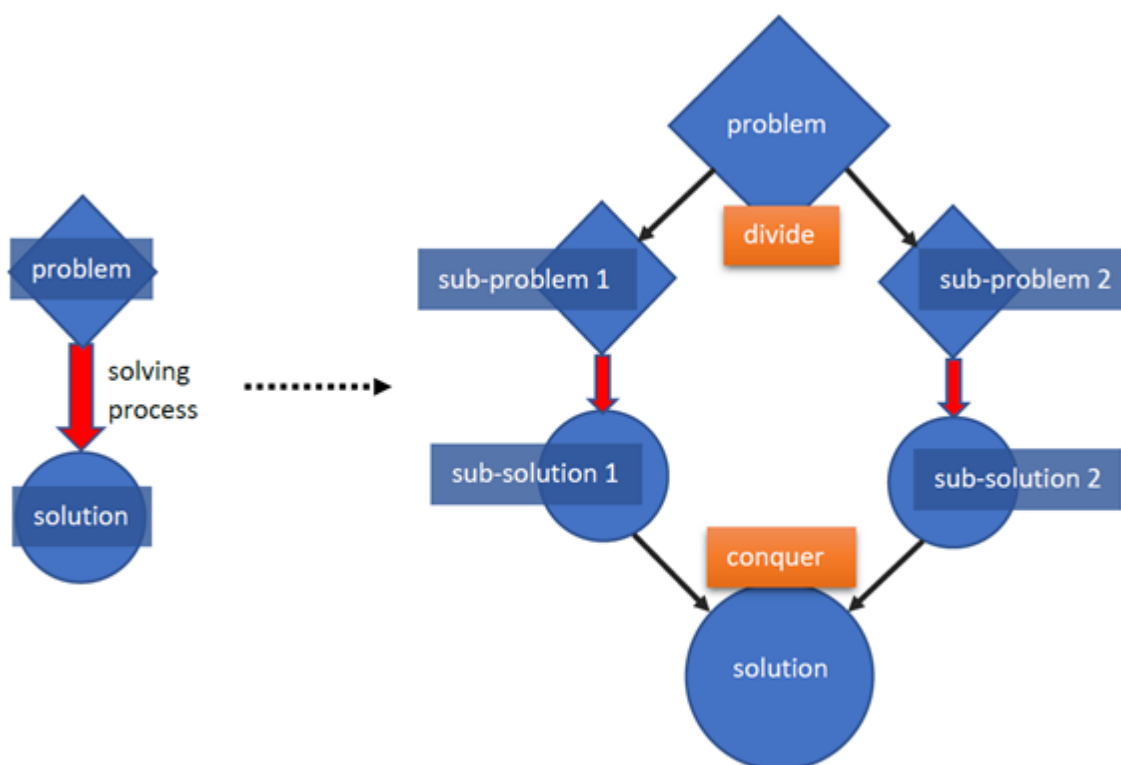

Fig. 1: Divide and Conquer

In these processes of breaking a problem down into several sub-problems and reassembling the partial solutions into an overall solution, we can observe all core steps regarding Computational Thinking. Thus, initially a problem is broken down into several similar but smaller sub-problems, which corresponds to "**Decomposition**". To do this, however, the problem must first be abstracted (**Abstraction**) and thus the patterns must also be recognised (Pattern Recognition). Subsequently, one must compile an overall solution for the original problem from recursively obtained solutions of the sub-problems. The CT-skill "**Algorithmic Thinking**" is used to create the partial solutions.



As an example, to illustrate the divide-and-conquer technique, we can look at a set of numbers to be sorted. Thus, an unsorted set of numbers is given. The result should be a sorted sequence of numbers. To sort the set of numbers, two subsets could initially be formed; these are sorted separately and then merged together. If possible, apply the same method to sort the subsets. When sorting with the Mergesort or Quicksort algorithms, for example, the sorted result sequence is made up of small sub-lists, each of which is sorted separately.

The divide-and-conquer technique is applied in many areas of computer science. In parsing programming languages, the division of computer programs into procedures, functions, modules, objects, components, processes and threads is implemented according to the principle of divide-and-conquer. The principle is also applied in numerous algorithms. This takes advantage of the fact that for many problems the effort required to solve them is reduced if the problem is broken down into smaller sub-problems. The sub-problems can be solved simultaneously in parallel or even sequentially before the sub-solutions are combined to form an overall solution.

With divide-and-conquer technique, there is also the possibility that the best solution for the overall problem is selected from the partial solutions according to certain criteria. An example of this would be an optimization problem. In some optimization problems the solution space is divided and the optimal solution is searched for from the subspaces. The best solution is then selected from the "subspace optimisations" as the overall solution.

Aims

- Knowing the definition of divide-and-conquer technique.
- Knowing how to apply the divide-and-conquer technique.
- Breaking down a problem into subtasks, whose solutions can be combined to form an overall solution.
- Knowing under which conditions divide-and-conquer technique supports parallelisation.
- Increasing the efficiency of algorithms through divide-and-conquer technique.
- Developing recursions in context with divide-and-conquer technique.
- Application of the paradigm divide-and-conquer strategy to develop recursive solutions.
- Application of the divide-and-conquer strategy to improve efficiency.
- Knowing which CT-skills are required to apply the divide-and-conquer technique.
- Based on the activities, prospective teachers practice the following skills:
 - Description of a problem
 - Identification of the details required to solve the problem
 - Splitting the problem into smaller steps
 - Creation of a process (algorithm) to solve the problem
 - Assessment of the process

To highlight the occurrences of the CT skills in correlation with informatics concepts we use the two-dimensional categorisation system for informatics tasks from Dagienė, Sentance and Stupurienė (2017).

| | Algorithms and programming | Data, data structures and representations | Computer processes and hardware | Communication and networking | Interactions, systems and society |
|-----------------------------|--|--|---|-------------------------------------|--|
| Abstraction | Identifying key elements in the problem in all activities using the Divide-and-Conquer method. | Description of relevant information. | | | |
| Algorithmic thinking | D&C is an essentially method of algorithmic thinking. All activities deal with algorithms. | | Parallel processing: based on some activities (e.g. 1.1, 1.2 or 2.1) aspects of parallel processing is discussed. | | |
| Decomposition | Splitting a problem into subproblems occurs in all activities because of the theme "Divide and Conquer". | | | | |
| Evaluation | D&C strategy enhances often the time efficiency | | | | |

| | | | | | |
|-----------------------|---|--|--|--|---|
| Generalisation | D&C can be applied in many different applications | | | | The method can be used to solve both simple daily problems and complex computer science problems as well. |
|-----------------------|---|--|--|--|---|

Tab. 1: Occurring CT skills and informatics concepts in a two-dimensional categorisation system (Dagienė, Sentance, Stupurienė, 2017, pp. 35-38).



Target group and prerequisites

The target group consists of prospective informatics teachers in tertiary education and their teacher educators.

Requirements

Required Pre-knowledge of prospective informatics teachers:

- Knowledge of Computational Thinking Skills (Abstraction, Decomposition, Generalisation, Evaluation, Algorithmic Thinking, ...).
- At least initial programming skills.
- Basic knowledge of algorithms and data structures.

Keywords

divide-and-conquer, decomposition, algorithm, algorithmic thinking, parallelisation, recursion



Learning Outcomes (LOs) and Assessment Methods

| Learning Outcomes: | Assessment Methods: |
|--|---|
| 1. (Understand) to be able to recognise thinking processes and CT procedures when solving problems with the help of divide-and-conquer | participation in discussions, evaluation of written work (essay) |
| 2. (Apply) to be able to derive the possible thought patterns used in problem solving with the algorithm design paradigm divide-and-conquer | Evaluation of programming tasks and written elaborations, discussions |

| | |
|---|--|
| 3. (Analyse, Evaluate) to be able to analyse and evaluate examples of exercises with regard to their suitability for teaching CT skills in the application of divide-and-conquer | Evaluation of written compositions (homework: feedback on the designed assignment) |
| 4. (Create) to be able to design assignments that promote Computational Thinking in problem solving through divide-and-conquer | Evaluation of written work (homework: designing an assignment) |

Tab. 2: Learning Outcomes and Assessment Methods



Unit 1

This unit comprises four sessions of 45 minutes each. The four sessions could take place on two different dates with a double session of 90 minutes each. In addition, there is an effort of 120 minutes for performing homework exercises. This module mainly consists of different activities in which the prospective teachers have to actively participate. Further important components of this module are group discussions as well as cooperation of the prospective teachers. A lecture is not part of this module, instead the results and experiences of the activities are discussed and debated in the plenum.

Unit 1.1 Divide-and-Conquer, Definition and Learning Activities

Brief description

The first two sessions generally refer to the divide-and-conquer technique. The concept of divide-and-conquer is introduced through several unplugged activities, which are carried out in small groups and are discussed in plenary afterwards.

Figure 2 shows the structure of Unit 1.1:

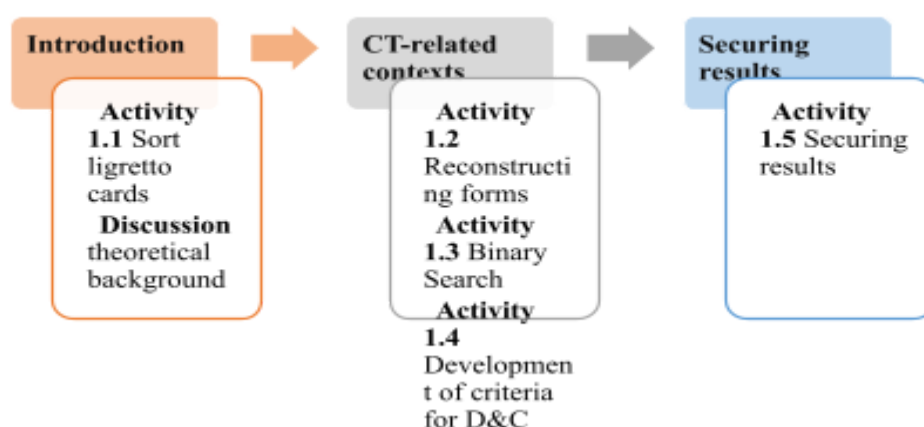

Fig. 2: Structure of unit 1.1

Detailed planning

The times for the first two sessions look like this:

| Phase Time (in min) | Content | Social Form | LOs Prospective teachers should be able to ... |
|---------------------------------------|--|-------------|---|
| Session 1 (45 min) | | | |
| Introduction 10 - 15 | Task 1.1: Sort ligretto cards Apply the divide-and-conquer technique through “clever” divisions of the sorting task | Group work | ... identify the divide-and-conquer technique. ... recognise subtasks (pattern recognition). ... assemble the partial solutions to form a complete solution. |
| Introduction 5 - 10 | Discussion 1.2: By means of discussion, the various possible solutions are discussed | Plenum | ... recognise that there are several possible solutions. ... recognise that it is primarily a matter of simplifying the problem by breaking it down into subtasks. ... define the divide-and-conquer technique. |
| CT-related contexts 20 - 30 | Task 1.2 and Task 1.3: Reconstructing forms and Binary Search 2 stations with 10-15 min each for one station incl. subsequent discussion Act. 1.2: Reconstructing forms: Applying the divide-and-conquer technique by "clever" division of the components and composition of these. Act. 1.3: Binary Search: By question-answer (yes/no) an arbitrary number should be found by applying the divide-conquer technique. | Group work | ... identify the divide-and-conquer technique. ... recognise subtasks (pattern recognition). ... assemble the partial solutions to form a complete solution. ... recognise that the principle is not based on parallelisation, but on the skillful division of the problem. ... recognise that the binary search only works quickly if the set is divided in each step into two nearly equal-sized parts. |
| Session 2 (45 min) | | | |
| CT-related contexts 25 - 30 | Task 1.4: Development of criteria for D&C In small groups (3-4 students), students should define criteria for | Group work | ... apply newly acquired techniques. |

| | | | |
|---|---|---|---|
| | <p>when Divide and Conquer can be applied. These criteria should be entered in the Word Cloud. Based on these criteria, the examples from daily life (Unit1_Examples_D&C.pdf) are to be analysed in small groups. Afterwards there will be a discussion about the results. (*)</p> | | |
| <p>Securing results (**) 10 - 15</p> | <p>Task 1.5: Reflecting on D&C To check the level of knowledge the teacher educator presents questions and statements regarding D&C. The prospective teachers should work on the questions and statements and hand in their results.</p> | <p>Individual work, Plenum</p> | <p>... remember the key aspects of CT in informatics.</p> |
| <p>Securing results 2 - 3</p> | <p>- Homework assignment - Outlook for the next two lessons</p> | <p>Frontal teaching</p> | |

Tab. 3: Detailed planning of Unit 1.1

(*) Key questions for discussion:

- What criteria have you identified in your group? Why?
- What criteria do you think are appropriate? Which ones are wrong?
- What would be an example where Divide and Conquer could be applied? / What would be an example against it?
- What criteria did you use to solve the examples?

Depending on how much time is needed for the first two phases, different methods are available in phase 3 (securing results/conclusion) for repeating the entire double session. These are indicated by (**) in table 3.

(**) An alternative teaching form is a teaching discussion. This method is usually used to solve a problem or task with an entire group/class. In a class discussion the teacher educator takes on the role of a moderator, so to speak, and stimulates contributions and guides the discussion. The aim of this class discussion is to make the prospective teachers aware of the essentials and to get them to reflect on the activities related to Computational Thinking.

Homework

1. Write an essay of 1.5-2 A4 pages (500-600 words).
2. Enter 3 words in an online tool (Word Cloud).

Further details can be found in “ Units and activities”.

Task 1.2 Divide-and-Conquer via recursion

Brief description

The second double session focuses on recursion in relation to the divide-and-conquer technique and the possible thought patterns that may be required in this approach. We will start with an unplugged task in two or more groups to recognise the thought patterns and later solve two programming tasks to be able to create assignments independently as homework.

Figure 3 shows the structure of Task 1.2:

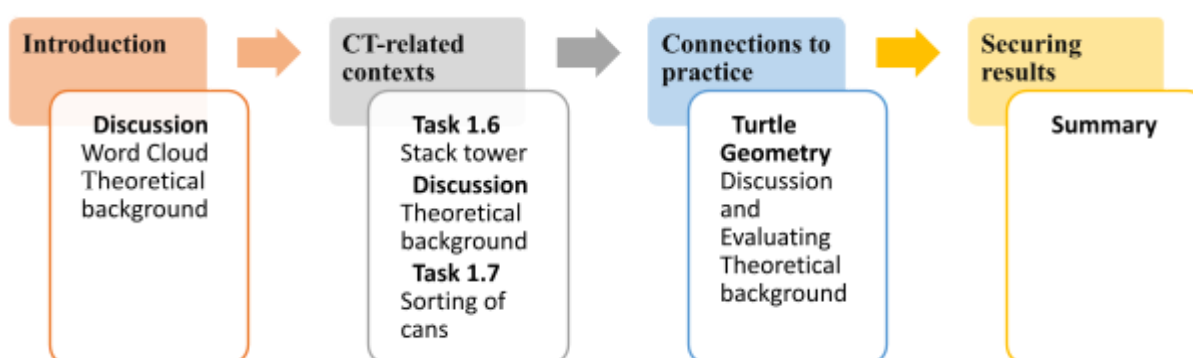

Fig. 3: Structure of Unit 1.2

Detailed planning

The times for the second two sessions look like this:

| Phase Time (in min) | Content | Social Form | LOs Prospective teachers should be able to ... |
|----------------------------------|---|-------------|---|
| Session 3 (45 min) | | | |
| Introduction 5-10 | Discussion about the homework "Word Cloud" | Plenum | |
| CT-related contexts 20 | Task 1.6: Stack tower Form groups of 6-8 persons. Solve the stack tower Write down your solution Give your solution to another group. Try to reproduce the given solution, add possible improvements and give a short feedback. | Group work | ... recognise thinking processes and CT procedures when solving problems with the help of the divide-and-conquer technique. |
| CT-related contexts 5 | 1. Discussion of the results of Task 1.6 2. Brainstorming CT | Plenum | ... identify possible thinking patterns when solving problems using the |

| | | | |
|--------------------------------------|---|------------------|--|
| | | | divide-and-conquer technique in combination with recursion. |
| CT-related contexts 15-20 | Task 1.7: Pseudocode: Sorting of cans | Group work | ... apply the thinking processes of divide-and-conquer and recursion themselves. |
| Session 4 (45 min) | | | |
| CT-related contexts 5-10 | Discussion of the results of Task 1.7 | Plenum | ... derive the possible thought patterns used in problem solving with the divide-and-conquer technique. |
| Connections to practice 20-25 | Turtle Geometry Programming of the task with Scratch | Plenum | ... apply recursion also to programming tasks. |
| Connections to practice 5-10 | Evaluate the exercises Possible solutions are to be presented by prospective teachers on the basis of the teaching discussion method. | Plenum | ... analyse and evaluate examples of exercises with regard to their suitability for teaching CT skills in the application of divide-and-conquer. |
| Securing results 5 | Summary by the teacher educator Homework assignment | Frontal teaching | |

Tab 4: Detailed planning of Unit 1.2

Homework

As homework, an exercise specification for divide-and-conquer should be created and uploaded within a week so that it can be given to two other prospective teachers.

A model solution should be created and the possible ways of thinking to solve the task should be written down.

After the assignment of two exercise details, these should be solved and 150 words of feedback should be written per task. Further details can be found in “ Units and activities”.



Units and activities

1. Structure of Unit 1.1

1.1 Introduction to the topic Divide-and-Conquer

Task 1.1: Ligretto cards

- A detailed description of Task 1.1 can be found in Unit1_DivideConquer_Activities.pdf.
- This is a "warm-up" task.
- The intention is to introduce prospective teachers to the basic processes of dividing and conquering.
- The teacher educator briefly explains the process and gives the prospective teachers a few minutes to think of a strategy to sort the cards as a team. Afterwards the first round starts.
- The motivation of the individual groups is possibly to break the existing record time. The question is which group will be the first to have the deck of cards correctly sorted in the middle of the group table.
- After that there is a short discussion with the whole class, after that the groups can exchange their ideas for a few minutes and then the second round starts.
- In the second round all groups are usually faster.
- After the second round, the teacher educator refers to parallelisation, multi-core processors in smartphones and discusses with the prospective teachers the connection between the principle and various topics, such as parallelisation and others.



Duration: 15-20 minutes



Group work

CT Reference of Task 1.1 (graphic was taken from module 2):

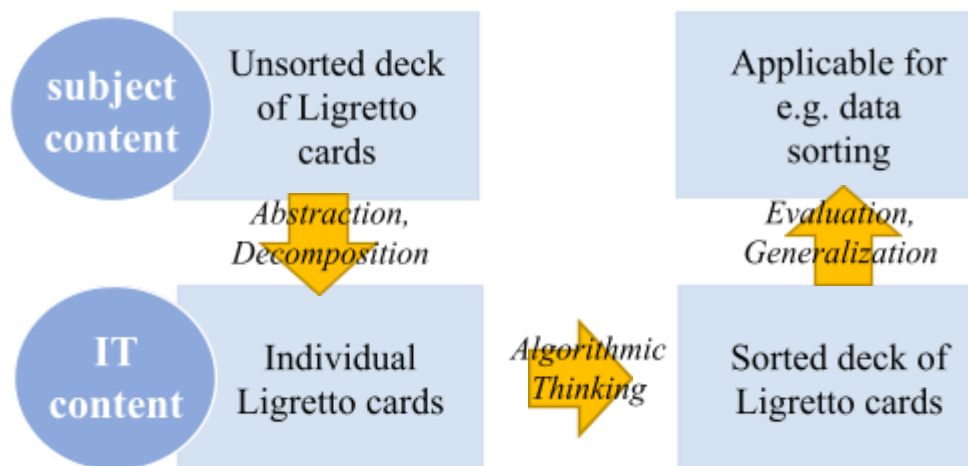

Fig. 5: Conceptualisation for Task 1.1

1.2. Development of the contents

The development phase consists of two sections:

- **First section:** Station operation (Task 1.2 and Task 1.3)
In the first section prospective teachers should form 2 groups. Each group works 10-15 minutes in a station and deepens the learning (divide-and-conquer) regarding CT skills (Decomposition, Abstraction, Algorithmic Thinking, Evaluation, Generalisation) from the introductory exercise.

Depending on how many prospective teachers are present and how many resources one has, the stations can be made available several times so that the prospective teachers can work in smaller groups.



Duration: 20-30 minutes



Group work

- **Second section:** In small groups (3-4 students), students should define criteria for when Divide and Conquer can be applied. These criteria should be entered in the Word Cloud (Online Tool: Mentimeter). Based on these criteria, the examples from daily life (Unit1_Examples_D&C.pdf) are to be analysed in small groups. Afterwards there will be a discussion about the results.



Duration: 25-30 minutes



Group work

Task 1.2: Reconstructing forms

- A detailed description of Task 1.2 can be found in Unit1_DivideConquer_Activities.pdf.
- This is a task for a better understanding of the divide-and-conquer technique.
- The intention here is that the basic processes of divide-and-conquer, which were already introduced in Task 1.1, are used to solve further problems.
- Deepening of what has been learned.



Duration: 10 - 15 minutes



Group work

CT Reference of Task 1.2 (graphic was taken from module 2):

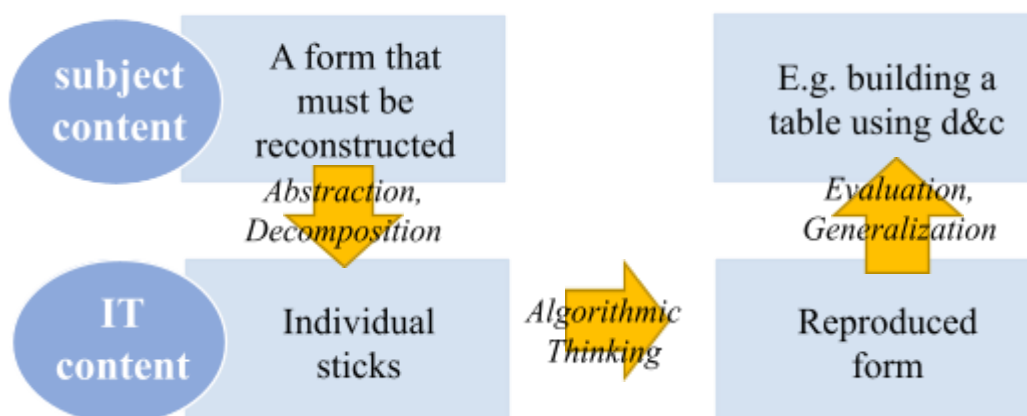

Fig. 6: Conceptualisation for Task 1.2

Task 1.3: Binary Search

- A detailed description of Task 1.3 can be found in Unit1_DivideConquer_Activities.pdf
- This is a task for a better understanding of the divide-and-conquer technique.
- The intention here is that the basic processes of divide-and-conquer, which were already introduced in Task 1.1, are used to solve further problems.
- Deepening of what has been learned.



Duration: 10 - 15 minutes



Group work

CT Reference of Task 1.3 (graphic was taken from module 2):

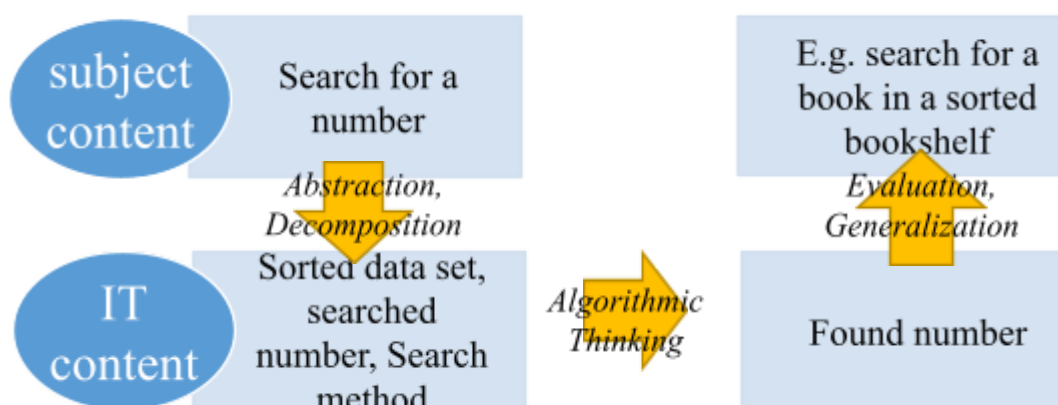

Fig. 7: Conceptualisation for Task 1.3

Task 1.4: Development of criteria for D&C

- This is a task for a better understanding of the divide-and-conquer technique.
- Which problems can be solved with D&C, which not?
- The intention is to identify under which conditions the divide-and-conquer technique can be applied using daily life examples.
- Process:
 - In small groups (3-4 students), students should find criteria for which kind of problems Divide and Conquer can be applied.
 - These criteria should be entered in a Word Cloud.
 - Based on these criteria, the examples from daily life (Unit1_Examples_D_C.pdf) are to be analysed in small groups.
 - Afterwards there is a discussion about the results
- Prospective teachers become active and reflect on the criteria.



Duration: 25-30 minutes



Group work

1.3. Securing results

The main purpose of securing results is to help learners. The purpose of result assurance is to work out the essential points of the lesson and thus make it clear to prospective teachers which important points have been dealt with.

At best, the methods for securing results support the transfer from working memory to long-term memory and thus the development of competences. The acquired knowledge should therefore be recorded in such a way that prospective teachers can access it in the long term.

Task 1.5: Securing results Task

- A detailed description of Task 1.5 can be found in Unit1_DivideConquer_Activities.pdf.
- This is a task to repeat the essential points.
- Process: Statements and questions are projected on the wall, each statement or question is projected on a PowerPoint slide (Unit1_1_SecuringResults.pptx), the prospective teachers are asked to decide whether a statement is true or false or to answer the questions.
Depending on the time available, the number of statements can be adjusted.
- The intention here is to deepen and consolidate the content that has been worked out.
- Teachers become active themselves and reflect on the statements and questions.



Duration: 7 - 8 minutes



Individual work



Unit1_1_SecuringResults.pdf

CT Reference of Task 1.5 (graphic was taken from module 2):

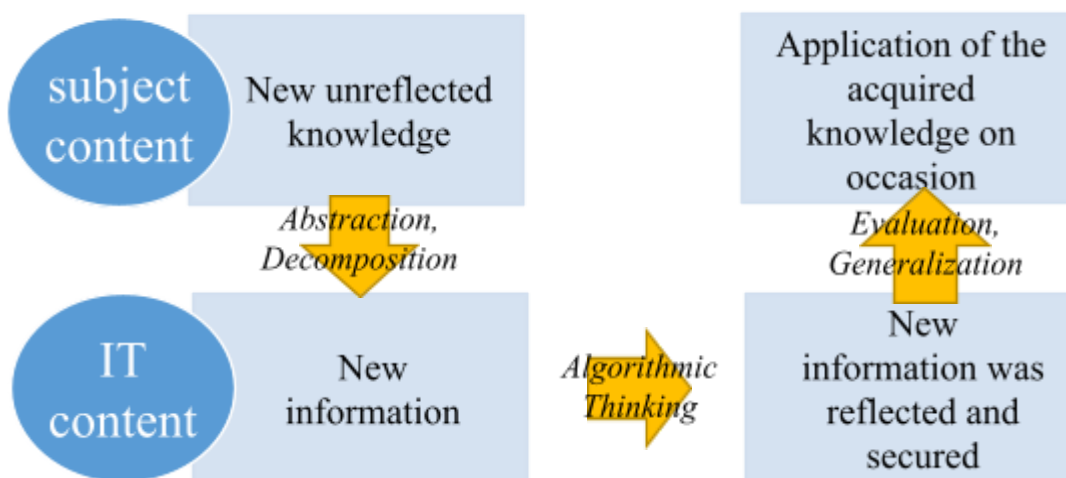

Fig. 8: Conceptualisation for Task 1.5

1.4. Homework assignment

1. Write an essay of 1.5 to 2 A4 pages (500-600 words).
 - a. You should first work out the criteria and then consider two examples of the pros and cons where divide-and-conquer can and cannot be applied.
 - b. Afterwards, you should reflect on the activities of the first two lessons. During the reflection, you should refer to the aspects of Computational Thinking.
2. Enter at least 3 words in an online tool (Word Cloud).
 - o You should enter at least 3 criteria for the applicability of divide-and-conquer into the online tool used for the word cloud in Task 1.4. The basis of your criteria should be the knowledge gained in all previous activities, with emphasis on Task 1.5.
 - o Timeframe: Within the following 5 days so that a word cloud can be formed for the next double session.
 - o The word cloud is used in the second double session to repeat the first double session.
 - o Mentimeter, for example, is a free tool that provides the functionality required for this example. But there are enough alternatives.



Duration: 90 minutes



Homework

Word Cloud. Mentimeter. <https://www.mentimeter.com/app>.

2. Structure of Unit 1.2

2.1 Entrance

Discussing word cloud

- To warm up the audience and repeat the last Unit, we make a discussion about the word cloud, that prospective teachers had to build online for last homework.
- Future teachers have the opportunity to express their thoughts on the chosen words.



Duration: 5-10 minutes



Plenum

2.2 Working period

Task 1.6: Stack Tower

- A detailed basic description of Task 1.6 can be found in Unit1_DivideConquer_Activities.pdf.
- The intention is to introduce prospective teachers to problem solving by recursion.
- At least two groups are formed, each solving the stack tower problem.
- Each group should then write down its own solution.
- The explanation is exchanged with another group.

- The respective other group must now try to play the given solution, add possible improvements and give a short feedback.



Duration: 20 minutes



Group work

CT Reference of Task 1.6 (graphic was taken from module 2):

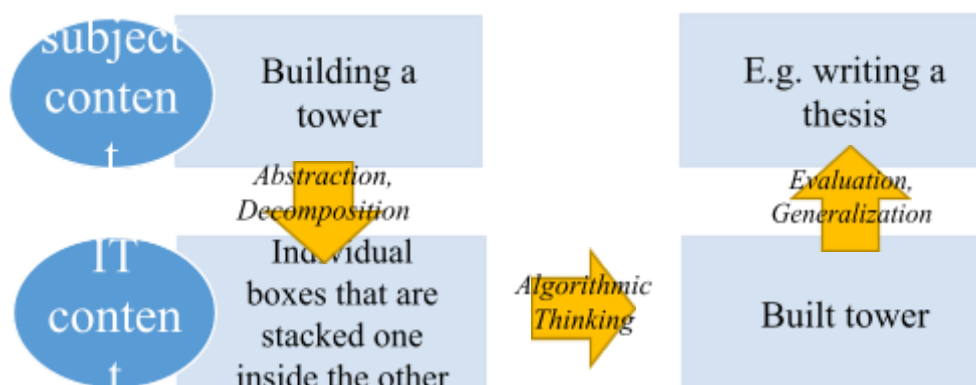

Fig. 9: Conceptualisation for Task 1.6

Discussion of the results of Task 1.6 / Brainstorming CT

- In this section, we discuss the findings of Task 1.6 and brainstorm about the possible patterns of Computational Thinking when solving problems by divide-and-conquer with recursion.
- In order to ensure the learning output, we have to perform a summarising elaboration.



Duration: 5 minutes



Plenum

Task 1.7: Sorting of cans

- Prospective teachers are confronted with a large number of cans of different weights. The weight of the cans is not visible from outside.
- For comparing the weight of 2 cans the prospective teachers are provided with a balance scale or provisionally with pencil and ruler.
- The future teachers have to find an algorithm to sort the cans by weight as quickly as possible.
- After the cans are sorted, a pseudo code for sorting the cans has to be developed.
- The teacher educator can, of course, help and guide the prospective teachers towards a MergeSort solution.



Duration: 15-20 minutes



Group work



Unit1_DivideConquer_Activities.pdf

CT Reference of Task 1.7 (graphic was taken from module 2):

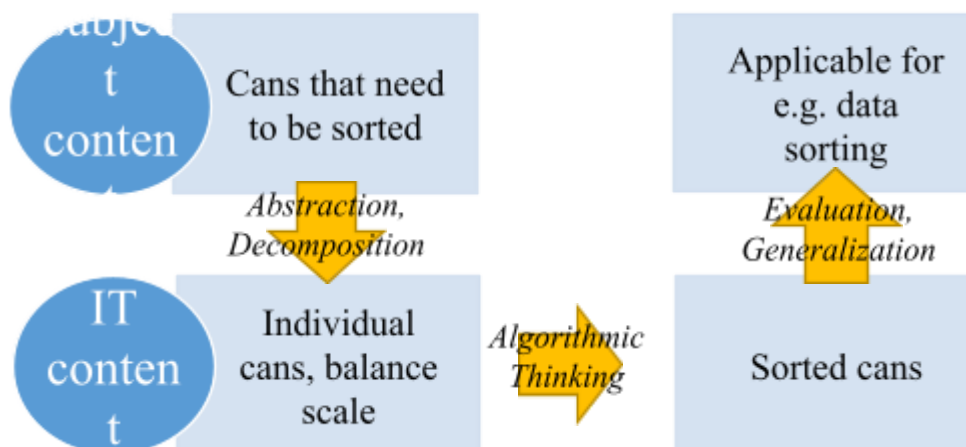

Fig. 10: Conceptualisation for Task 1.7

Turtle geometry

- The prospective teachers are shown a picture of a snowflake drawn by a recursive turtle geometry program.
- The prospective teachers should discuss the recursive structure of the picture.
- They will then be introduced to scratch and turtle geometry by the teacher educator.
- The teacher educator then solves the problem step by step with help of the auditorium.



Duration: 20-25 minutes



Plenum



Unit1_TurtleGeometry.pdf

CT Reference of Task “Turtle geometry” (graphic was taken from module 2):

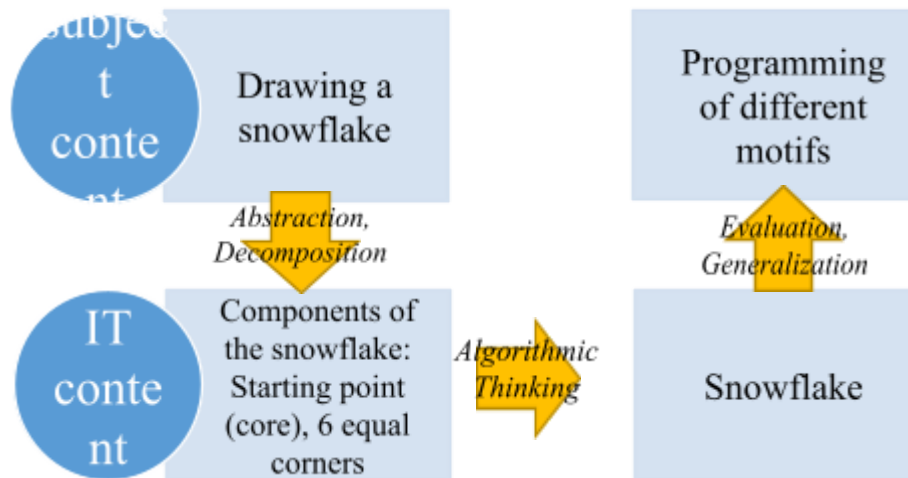

Fig. 11: Conceptualisation for Task "Turtle geometry"

Evaluate the exercise

- In the plenum, the possible thought patterns that were used to draw the turtle geometry picture are discussed.
- The quality of the two tasks for the mediation of CT is now being discussed in the plenum.
- Criteria for good tasks for understanding recursion are discussed in the plenum.



Duration: 5-10 minutes



Plenum

2.3 Securing results

Summary

- For quality assurance, a summary is provided by the teacher educator.
- The most important thought patterns in solving divide-and-conquer problems are repeated.
- The suitability of exercises for teaching the divide-and-conquer technique is also discussed.



Duration: 5 minutes



Frontal teaching

1.4. Homework assignment

- As homework, a specification for a divide-and-conquer task should be created and uploaded within a week so that it can be given to other prospective teachers.

- A model solution of the task should be created and the possible ways of thinking to solve the task should be explored and described.



Duration: ~100 minutes



Homework



Assessment requirements and assessment strategy

All assessment tasks should be handed in before the deadline set.

| Assessment task (Unit 1) | Assessment criteria and method (Unit 1) |
|---|--|
| 1. Essay | Length: 500-600 words Structure: clear structure with introduction, main part, conclusion Content: Reference to Computational Thinking must be clearly visible. |
| 2. Word Cloud | Participated/not participated |
| 3. Cooperation in discussions | Participation in the discussions |
| 4. Create Task | <ul style="list-style-type: none"> • Originality • Development of the CT thought patterns • Comprehensibility • Feasibility • Target group orientation • Usability for the mediation of divide-and-conquer with recursion. |
| 5. Evaluation of the two given examples | <ul style="list-style-type: none"> • Does the prospective teacher address the usefulness of the examples for teaching computational thinking patterns? • Does the prospective teacher recognise whether an example conveys the thought patterns? • Is the feasibility and target group orientation addressed? |

Tab. 4: Assessment requirements and assessment strategy



Learning resources



- Detailed descriptions of the activities; Unit1_DivideConquer_Activities.pdf .
- Examples with D&C about daily life; Unit1_Examples_D&C.pdf
- Examples with D&C about daily life incl. solutions; Unit1_Examples_D&C_forEducator.pdf
- Statements, Questions for the task “Securing results”; Unit1_1_SecuringResults.pptx
- Programming task & sample solution of the activity turtle geometry; Unit1_TurtleGeometry.pdf
- Sample solution of the task “Sort cans”; sort_data.pdf



- Algorithm: Mergesort. <https://www.youtube.com/watch?v=JSceec-wEyw>
- Algorithm: Binary Search. Short description (0:0-2:07) <https://www.youtube.com/watch?v=P3YID7liBug>



- Word Cloud. Mentimeter. <https://www.mentimeter.com/app>.
- Scratch-Online-Plattform. <https://scratch.mit.edu/>.



Implementation ideas

- For an example of classroom implementation, see Table 3 and Table 4 under " Unit plan".
- In station operation, you can let the two groups try out just one station. Each group then explains what they had to do and their findings.
- Depending on the desired teaching style, the lecturer can give a short input on the divide-and-conquer technique instead of the station operation and then play through Task 1.3 (Binary Search) with the whole class. As an introduction or summary for Task 1.3 a video (see References) could be shown.
- In Task 1.2, work phase 2 sorting data can be omitted, if necessary.
- Task 1.6 Stack tower stands on its own and can be used as part of a teaching unit.

- The same applies to Turtle Geometry, which also offers a very clear approach to divide-and-conquer through its visuality.
- The creation of an example task does not have to be given as homework, but can also be used as part of presence teaching. It is just noted that this work is very time-consuming.



References

Dagienè, V., & Sentance, S. (2016, October). It's computational thinking! Bebras tasks in the curriculum. In *International conference on informatics in schools: Situation, evolution, and perspectives* (pp. 28-39). Springer, Cham.

Dagienè, V., Sentance, S., & Stupurienè, G. (2017). Developing a two-dimensional categorization system for educational tasks in informatics. *Informatica*, 28(1), 23-44.

Amer, Aly. "Reflections on Bloom's revised taxonomy." *Electronic Journal of Research in Educational Psychology* 4.1 (2006): 213-230.

Jones, C. (2010). Interdisciplinary approach-advantages, disadvantages, and the future benefits of interdisciplinary studies. *Essai*, 7(1), 26.

GeeksforGeeks. MergeSort. URL: <https://www.geeksforgeeks.org/merge-sort/>.



Additional resources

- In advance of his module, Output 2 should be processed, since Output 2 deals with the basics of Computational Thinking. In this module the knowledge of CT skills are a prerequisite.
- It might be possible to continue with Unit 2 "CT aspects of codes" (O6 - Module 2).
- Fadel, Charles, Maya Bialik, und Bernie Trilling. *Four-Dimensional Education*, 2018.
- Papert, Seymour. *Mindstorms: children, computers, and powerful ideas*. 2nd ed. New York: Basic Books, 1993.



Appendix 1: Material for students - future teachers

- Detailed descriptions of the activities; Unit1_DivideConquer_Activities.pdf
- Examples with D&C about daily life; Unit1_Examples_D&C.pdf
- Statements, Questions for task "Securing results"; Unit1_1_SecuringResults.pptx

- Programming task & sample solution of the act. turtle geometry; Unit1_TurtleGeometry.pdf
- Sample solution of the task sort cans; Unit1_SolutionSortCans.pdf



- YouTube: introducing merge-sort and quick-sort followed by a comparison of both sorting algorithms; <https://www.youtube.com/watch?v=es2T6KY45cA>



Appendix 2: Material for school teachers to be used in class

- Detailed descriptions of the activities; Unit1_DivideConquer_Activities.pdf
- Examples with D&C about daily life; Unit1_Examples_D&C.pdf
- Examples with D&C about daily life incl. solutions; Unit1_Examples_D&C_forEducator.pdf
- Statements, Questions for the task “Securing results”; Unit1_1_SecuringResults.pptx
- Programming task & sample solution of the act. turtle geometry; Unit1_TurtleGeometry.pdf

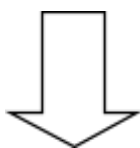

Unit 2. CT aspects of codes

Module *outline* is based on the work within the project “Future Teachers Education: Computational Thinking and STEAM” (TeaEdu4CT). Coordination: Prof. Valentina Dagienė, Vilnius University, Lithuania. Partners: Vienna University of Technology (Austria), CARDET (Cyprus), Tallinn University (Estonia), University of Turku (Finland), Paderborn University (Germany), CESIE (Italy), Radboud University (Netherlands), KTH Royal Institute of Technology (Sweden), Ankara University (Turkey). The project has received co-funding by the Erasmus+ Programme KA2.

TeaEdu4CT project (grant no. 2019-1-LT01-KA203-060767) 2019 license granted.





General overview and aim

Unit 2 - CT aspects of codes

This unit covers computational thinking aspects of codes and binary codes in particular. Binary codes are developed and analyzed through inquiry-based learning. A series of tasks and activities lead the prospective informatics teachers from fixed-length code via variable-length code to Huffman code.

All activities and tasks are unplugged and are strongly related to informatics. Due to unplugged activities, there are no potential distractions by new software or technologies. Thus, the focus can be put on CT and informatics.

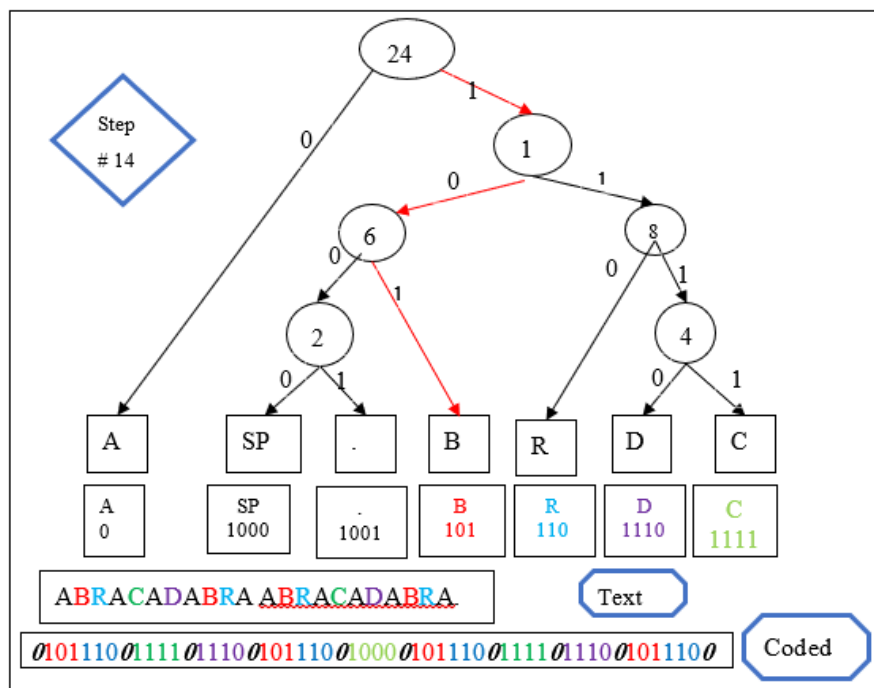

Fig. 1: Huffman coding, the final tree of of a Huffman code (Abu-Taieh, 2018)

Aims

- Understand binary codes.
- Determine the minimal length needed when using fixed-length code.
- Develop a fixed-length code for a small set of symbols.
- Describe an algorithm to create a fixed-length code for a set of symbols.
- Develop a variable-length code for a small set of symbols.
- Know the definition of a prefix code.
- Know the definition of a Huffman code.
- Know which CT skills are required to apply codes, such as Huffman code.
- Know some applications of code and Huffman code in particular.

To highlight the occurrences of CT skills in correlation with informatics concepts we use the two-dimensional categorization system for informatics tasks from Dagienė, Sentance and Stupurienė (2017).

| | Algorithms and programming | Data, data structures and representations | Computer processes and hardware | Communication and networking | Interaction, systems and society |
|-----------------------------|--|--|--|--|---|
| Abstraction | Choose the relevant properties of an application for coding | Binary code. Tree representation of prefix codes. | | | |
| Algorithmic thinking | How to construct a prefix code. How to construct a Huffman code. | How to construct a prefix tree. How to construct a minimal prefix tree. | | | |
| Decomposition | | | | | |
| Evaluation | Is a code uniquely decodable? What is the average word length of a code? Is a code minimal? Is a code a Huffman code? | | | | |
| Generalization | | | | Application of codes in data transmission. | |

Tab. 1: Occurring CT skills and informatics concepts in a two-dimensional categorization system (Dagienė, Sentance, Stupurienė, 2017, pp. 35-38).



Target group and prerequisites

The target group consists of prospective informatics teachers in tertiary education and their teacher educators.

Requirements

Required Pre-knowledge of prospective informatics teachers:

- Knowledge of Computational Thinking Skills (Abstraction, Decomposition, Generalisation, Evaluation, Algorithmic Thinking, Evaluation...).
- Introduction to algorithms and data structures.

Keywords

Huffman code, modelling, coding, encoding, codes, fixed-length code, variable-length code



Learning Outcomes (LOs) and Assessment Methods

| Learning Outcomes: | Assessment Methods: |
|--|--|
| 1. (Remember) to be able to recall the definitions of binary codes, fixed-length codes and variable-length codes. | Evaluation through the participation in discussions and homework 2.b. |
| 2. (Understand) to be able to compare codes regarding the lengths of the encoded texts respectively their average word lengths. | Various tasks and the following presentations and discussions will show if the learning outcome is achieved. |
| 3. (Apply) to be able to implement fixed-length and variable-length binary codes. | Activity 2.2, homework 2.a and homework 2.b can be used for assessment. |
| 4. (Evaluate) to be able to check if a given code is uniquely decodable. | Evaluation through the results of activity 2.3. Similar tasks can be used additionally. |
| 5. (Create) to be able to generate fixed-length as well as variable-length binary codes. | Due to the inquiry-based learning approach, the prospective informatics teachers have to create their own codes multiple times (see activity 2.1, 2.2, 2.4 and 2.6). All of these activities can be used for assessment. |

Tab. 2: Learning Outcomes and Assessment Methods



Unit 2 - CT aspects of codes

Brief description

This unit consists of 2 parts (Unit 2.1 and Unit 2.2). Both parts consist of 2 sessions à 45 minutes.

This unit focuses on the CT aspects of binary codes. The goal is to know and describe the CT aspects that are involved in the creation of a binary code of variable length to an alphabet with a given probability distribution. For this purpose, binary codes of fixed and variable word length are analyzed and self-developed, with the emphasis on the occurring CT skills.

In the introductory activity, binary codes and their properties, in general, are worked out step by step. Thereby, the prospective computer science teachers are guided from an arbitrary self-made code to computational binary codes. Starting from binary codes with fixed word length, codes with variable word length are introduced and developed to reduce the total message length. With an emphasis on CT, properties of binary variable-length codes are determined and analyzed.

Finally, the Huffman Code is introduced to the prospective informatics teachers and explained how it can be created. The CT and informatics aspects of binary codes are repeated and summarized.

Figure 2 shows the structure of Unit 2.1:

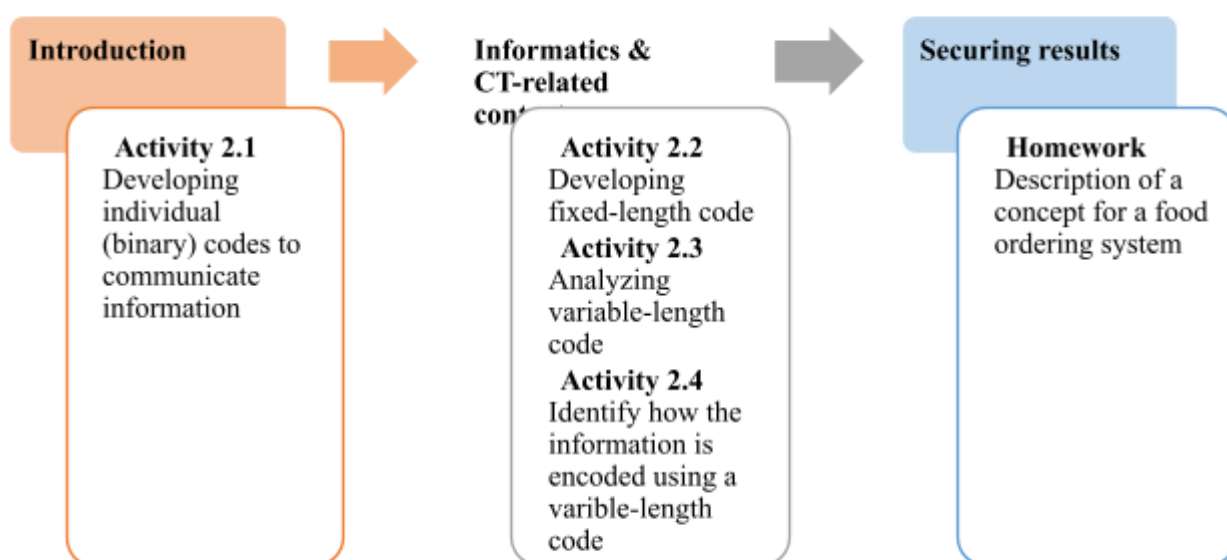

Fig. 2: Structure of unit 2.1

Detailed planning

The schedule for the first double-session “unit 2.1” (90 min) looks like this:

| Phase Time (in min) | Content | Social Form | LOs Prospective teachers should be able to ... |
|--|---|------------------|--|
| Session 1 | | | |
| Introduction 30 | Activity 2.1: Developing individual (binary) codes Introduction to codes and communication through codes a) Create a code for five given messages b) Create a binary code for the five messages of a) c) Create a binary code to transmit any messages | Group work | ... create a binary code for a set of given symbols to encode. |
| Informatics & CT-related contexts 15 | Activity 2.2: Ice Cream Shop 1 In this activity, the prospective informatics teachers should solve a task in which a fixed-length code should be created. | Individual work | ... create a fixed-length binary code. ... determine the required minimal code length of a fixed-length code of a set of given symbols. |
| Session 2 | | | |
| Informatics & CT-related contexts 15 | Activity 2.3: Fireworks The prospective informatics teachers solve the task Unit2_Activity_2.3_Firework s.docx. Afterwards it will be discussed. | Individual work | ... determine if a given code is uniquely decodable. |
| Informatics & CT-related contexts 25 | Activity 2.4: Code split a) Based on a given variable-length encoded word, the encoding of the individual characters has to be determined. b) An individual binary variable-length code for a given word should be created. | Individual work | ... create a variable-length binary code for a given set of symbols. |
| Securing results 5 | Homework assignment | Frontal teaching | |

Tab. 3: Detailed planning unit 2.1

Homework 2.a

Description of a concept for a food ordering system and the included informatics concepts regarding Dagienè, Sentance and Stupurienè (2017), as well as the included CT skills, based on the graphic of module 2 regarding the subject content and the IT content. Further details can be found in “☎️ Units and activities”.

Figure 3 shows the structure of Unit 2.2:

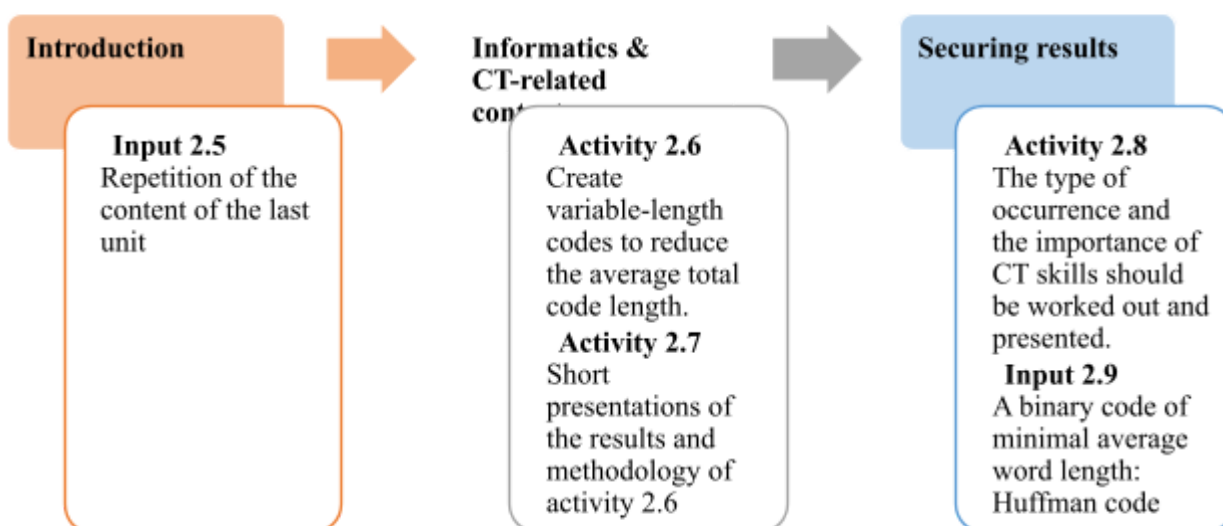

Fig. 3: Structure of unit 2.2

The schedule for the second double-session “unit 2.2” (90 min) looks like this:

| Phase Time (in min) | Content | Social Form | LOs Prospective teachers should be able to ... |
|-------------------------------------|--|-------------|---|
| Session 3 | | | |
| Introduction 5 | Input 2.5: Short repetition and elaboration The last unit should be summarized briefly so that everyone is up to date. | Plenum | |
| Informatics & CT-related | Activity 2.6: Ice Cream Shop 2 | Group work | ... create a uniquely decodable variable-length |

| | | | |
|---|--|-----------------------|---|
| contexts 15 | Creation of variable-length codes with the goal to reduce the average total code length. | | binary code. |
| Informatics & CT-related contexts 25 | Activity 2.7: Presentations of the results of activity 2.6 Short presentations of the results and methodology | Plenum | ... explain criteria of uniquely decodable variable-length codes. |
| Session 4 | | | |
| Securing results 20 | Activity 2.8: CT chart The CT skills are developed and discussed by the prospective informatics teachers using the Expert Discussion method. | Group work/ Plenum | ... name and describe relevant CT skills for creating codes. |
| Securing results 20 | Input 2.9: Minimal average word length A brief presentation to summarize and complete fixed-length, variable-length and Huffman code is given by the lecturer. | Frontal teaching | ... describe the difference between fixed-length and variable-length codes. ... understand the algorithm to create a Huffman code. |
| Securing results 5 | Homework assignment | Frontal teaching | |

Tab. 4: Detailed planning of unit 2.2

Homework 2.b

2. Create an exercise.

Further details can be found in “ Units and activities”.



Units and activities

1. Structure of Unit 2.1

1.1 Introduction to the topic CT aspects of encoding

Activity 2.1 Developing individual (binary) codes

- This is a "warm-up" activity.
- The prospective informatics teachers should encode messages to communicate through gestures and other codes.



Duration: 30 minutes



Group work



Unit2_Activity_2.1_CreatingCodes.pdf

1.2. CT-related contexts and connections to practice

Activity 2.2 Ice Cream Shop 1 (fixed-length code)

- Introductory activity to the topic.
- In this activity the prospective informatics teachers should solve a task in which a fixed-length code should be created.
- The required minimum code length should be recognized and determined.
- The code should be analyzed for the uniqueness of the individual elements.
- The prospective informatics teachers should thus experience the thought processes and the application of the CT skills.



Duration: 15-20 minutes



Individual work



Unit2_Activity_2.2_IceShop1.pdf

Activity 2.3: Fireworks

- This activity is based on the Bebras-task “Fireworks” from 2015.
- The core of this task is to recognize the problem of possible ambiguity in variable-length code.
- Prospective teachers should recognize that some code sequences have more than one meaning.
- The prospective teachers should determine characteristics of variable-length codes regarding uniqueness, respectively ambiguity.



Duration: 15 minutes



Individual work



Unit2_Activity_2.3_Fireworks

Activity 2.4: Code Split

- In the given task sheet Unit2_Activity_2.4_SplitTheCode.docx the prospective

informatics teachers should a) break a given prefix code and b) create their own binary variable-length prefix code.

- After completing the tasks, the solutions and results are discussed in plenary. Three different solutions should be presented by the prospective informatics teachers.
- To bring everything in context and summarize it, the graphic regarding subject content, IT content and CT skills (taken from module 2) should be filled out in plenary. If there is too little time left, the figure and the table are presented and explained by the lecturer.

An example is given below:

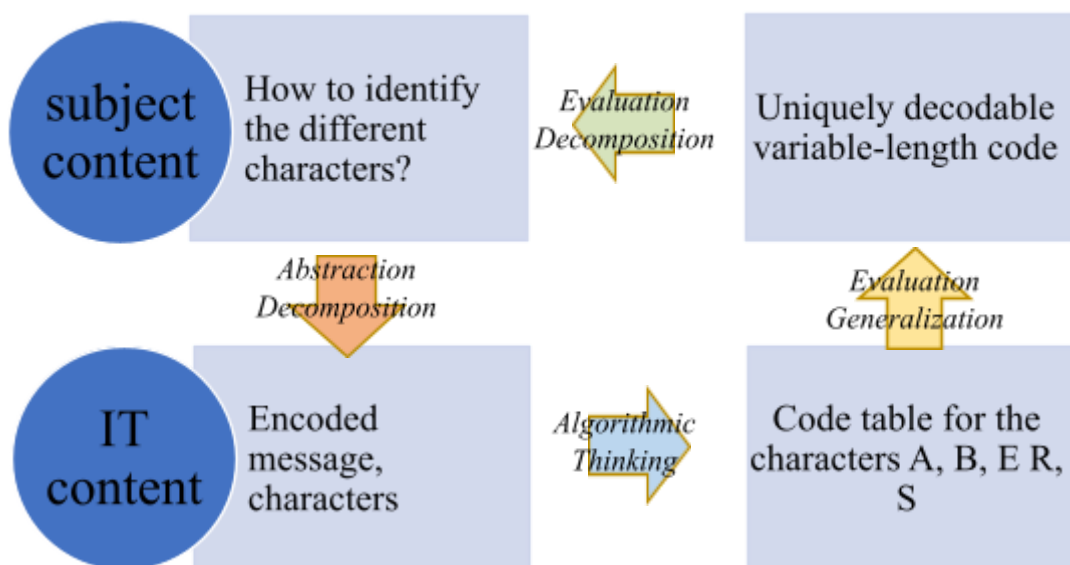

Fig. 4: Conceptualization Activity 2.4

| CT skills | Specifications regarding the concrete problem |
|-----------------------------|--|
| <i>Abstraction</i> | Consider the word BEBRAS as a meaningless string with the characters B, E, R, A and S. |
| <i>Decomposition</i> | Dividing the whole word BEBRAS in a string of six characters. Recognizing patterns in the encoded string. The same characters have the same code words. |
| <i>Algorithmic thinking</i> | Splitting the encoded string into substrings so that equal characters have equal code words and no code word contains a different code word at the beginning. |
| <i>Evaluation</i> | Analyze if the determined code is uniquely decodable. |
| <i>Generalization</i> | Determine characteristics of variable-length codes to create other variable-length codes. Determine requirements for variable-length codes that can be generated automatically. |
| <i>Evaluation</i> | Analyze if the code can be improved - regarding length, computational processability, etc. |

| | |
|----------------------|--|
| Decomposition | Break down and analyze the transmission of messages using the variable-length code of this task: What are possible reasons for choosing this code? Why are the characters encoded via variable-length code? What would be the minimal length of the encoded string if a fixed-length code was used? etc. |
|----------------------|--|



Duration: 25 minutes



Individual work



Plenum



Unit2_Activity_2.4_SplitTheCode.pdf

1.4. Homework assignment

Homework 2.a: Components and CT aspects of a food ordering system

- By conceptual development of an ordering system for fast food, the informatics and CT aspects regarding codes should be worked out and described.
- The following graphic (taken from module 2) should be filled out, and the occurring CT skills should be described in the table below.
- For further details see Unit2_Homework_2a_FoodOrderingSystem.docx.

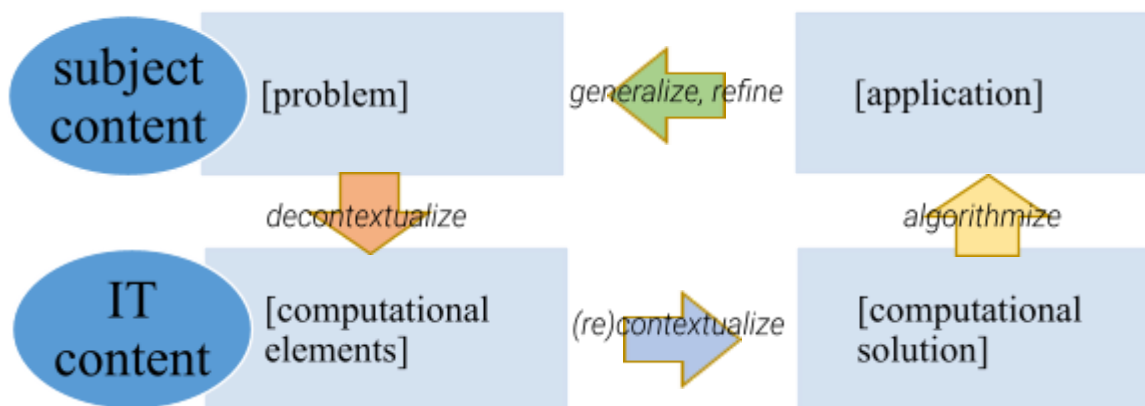

CT skills

Specifications regarding the concrete problem

| | |
|--|--|
| | |
| | |
| | |
| | |



Duration: 90 minutes



Homework



Individual work



Unit2_Homework_2a_FoodOrderingSystem.pdf

2. Structure of Unit 2.2

2.1 Introduction to the topic CT aspects of encoding

Input 2.5: Short repetition and elaboration

- The last unit should be repeated briefly so that everyone is up to date and the criteria uniqueness of variable length code should be worked out together using the teacher-student conversation method.



Duration: 5 minutes



Plenum

2.2. Development of the contents

Activity 2.6: Ice Cream Shop 2

- Continuation of Ice Cream Shop 1.
- The tasks can be taken from Unit2_Activity_2.6_IceShop2.docx.
- Now the prospective teachers should encode using a self-developed variable-length code. Therefore the ordering frequency of the ice cream flavours are given.



Duration: 15 minutes



Group work



Unit2_Activity_2.6_IceShop2.pdf

Activity 2.7 Presentations of the results of activity 2.6

- In short presentations, the results of activity 2.6 shall be presented and discussed.
- In the discussions, the differences between the results shall be pointed out, and possible optimizations elaborated.



Duration: 25 minutes



Group work

2.3. Securing results

Activity 2.8: CT chart

Preparations:

- The prospective informatics teachers are divided into groups of five.
- Each group will be provided with five rating strips in one colour (see Unit2_CT-Chart_Template_Rating-Strips.pdf).

Implementation:

The activity will be carried out in three phases:

- 1) Individual phase (5 min): Each person in the group specializes in one CT skill. The characteristics of each CT skill should be described and the importance of each skill in terms of codes should be indicated on a discrete scale. The scale goes from 0 to 5, with 5 being the highest and 0 the lowest importance.
- 2) Discussion in the group (5 min): After all group members have individually dealt with a CT skill, they should exchange their insights. At the end of the discussion, all groups have a score for each CT skill and can describe the way it occurs.
- 3) Plenum discussion (5 min): At the beginning of the plenum discussion the CT chart is made up of all the rating strips. Thereby similarities and differences become visible. Depending on the time available, the CT chart and the different scores can be discussed.

Adjustments:

If the number of students is not a multiple of five, groups of six people can also be formed. In this case, two group members will work on the same CT skill together.

The following figure shows an example of a CT chart created with five groups - one colour for each group.

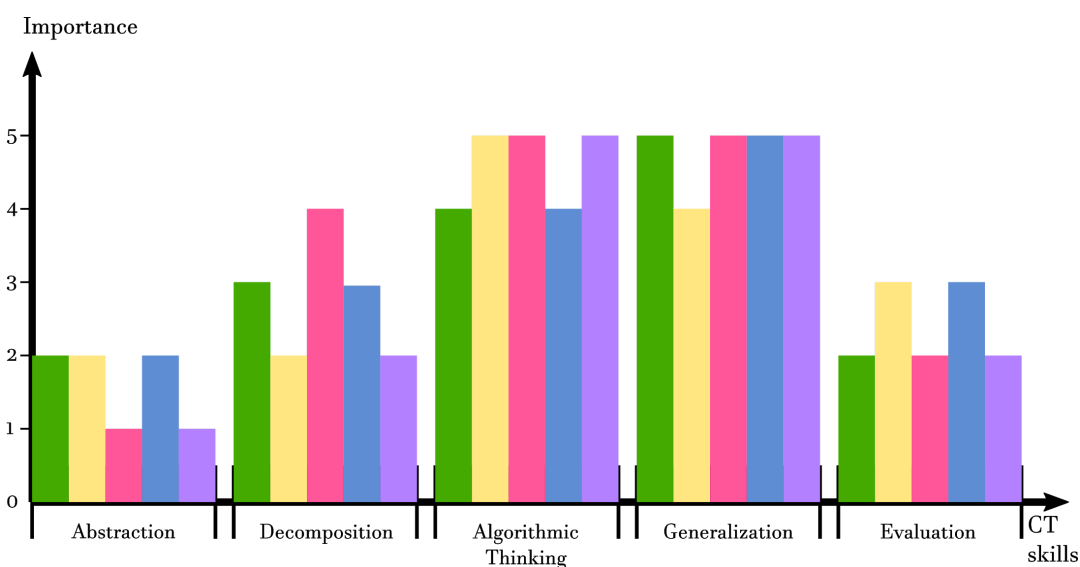

Fig. 5: Example of a CT chart



Duration: 20 minutes



Group work



Plenum

Input 2.9: A binary code of minimal average word length: Huffman code

- Brief lecture on Huffman code.
- Presentation slides can be found at Unit2_HuffmanCode.pptx.



Duration: 20 minutes



Frontal teaching



Unit2_HuffmanCode.pdf

2.4. Homework assignment

Homework 2.b: Creating a new Bebras task.

Prospective informatics teachers should create a new Bebras task about Codes with CT-Background. They should also describe the involved CT skills, the relation of the task to informatics and everyday life.



Duration: ~100 minutes



Homework



Assessment requirements and assessment strategy

All assessment tasks should be handed in before the deadline set.

| Assessment task | Assessment criteria and method |
|--|--|
| 1. Participation in discussions | Individual assessment Each one is evaluated individually: <ul style="list-style-type: none"> - Participated - Not participated - An extra note for particularly good arguments |
| 2. Homework 2.a Description of a concept for a food ordering system | Content: <ul style="list-style-type: none"> - Description of the informatics concepts and the informatics reference. - Content of the graphic regarding subject and IT content. - Description of the occurring CT skills. |
| 3. Homework 2.b Create a new task | <ul style="list-style-type: none"> - Reference to coding - Development of the CT thought patterns - Originality - Comprehensibility - Feasibility - Target group orientation (for students) |

Tab. 4: Assessment requirements and assessment strategy



Learning resources

- Task sheet for creating (binary) codes; Unit2_Activity_2.1_CreatingCodes.docx.
- Task sheet regarding fixed-length codes; Unit2_Activity_2.2_IceShop1.docx
- Task sheet from Bebras contest regarding variable-length codes; Unit2_Activity_2.3_Fireworks.docx
- Task sheet from Bebras contest regarding prefix codes; Unit2_Activity_2.4_SplitTheCode.docx
- Task sheet to variable-length codes considering the frequency of symbols to be encoded; Unit2_Activity_2.6_IceShop2.docx



Implementation ideas



References

Dagienè, Valentina, and Sue Sentance. "It's computational thinking! Bebras tasks in the curriculum." *International Conference on Informatics in Schools: Situation, Evolution, and Perspectives*. Springer, Cham, 2016.

Amer, Aly. "Reflections on Bloom's revised taxonomy." *Electronic Journal of Research in Educational Psychology* 4.1 (2006): 213-230.

Jones, Casey. "Interdisciplinary approach-advantages, disadvantages, and the future benefits of interdisciplinary studies." *Essai* 7.1 (2010): 26.

Abu-Taieh, E. "The pillars of lossless compression algorithms a road map and genealogy tree." *International Journal of Applied Engineering Research*, 13(6), 3296-3414, (2018): 3399-3400.

Imhof, Julia "Leitprogrammartige Unterlagen zur Huffman-Codierung" ETH Zürich (2019).



Additional resources

- In advance of this module, Output 2 should be processed, since Output 2 deals with the basics of Computational Thinking. In this module the knowledge of CT skills are a prerequisite.
- It might be possible to continue with Module 2 "Huffman Code" (O6 - Module 2).
- Fadel, Charles, Maya Bialik, und Bernie Trilling. *Four-Dimensional Education*, 2018.
- Papert, Seymour. *Mindstorms: children, computers, and powerful ideas*. 2nd ed. New York: Basic Books, 1993.



Appendix 1: Material for students - future teachers



Appendix 2: Material for school teachers to be used in class



Unit 3. CT aspects of computer simulations

Module *outline* is based on the work within the project “Future Teachers Education: Computational Thinking and STEAM” (TeaEdu4CT). Coordination: Prof. Valentina Dagienė, Vilnius University, Lithuania. Partners: Vienna University of Technology (Austria), CARDET (Cyprus), Tallinn University (Estonia), University of Turku (Finland), Paderborn University (Germany), CESIE (Italy), Radboud University (Netherlands), KTH Royal Institute of Technology (Sweden), Ankara University (Turkey). The project has received co-funding by the Erasmus+ Programme KA2.

TeaEdu4CT project (grant no. 2019-1-LT01-KA203-060767) 2019 license granted.





General overview and aim

Unit 3 - CT aspects of computer simulations

This unit comprises four sessions of 45 minutes each. The four sessions are proposed to take place on two different dates with a double session of 90 minutes each. In addition, there is an effort of 225 minutes for performing homework exercises.

In this unit the prospective informatics teachers have to examine and develop computer simulations with regard to CT. In order to get a connection to everyday life and informatics the prospective informatics teachers should program a virus simulation with StarLogo TNG. For future reference and assessment the work should be documented using a provided template (see Appendix 1).

Aims

- Know which CT skills are required in which contexts to develop a computer simulation.
- Determine relevant parameters of a viral disease for programming a virus simulation.
- Getting to know methods for programming simulations.
- Generalizing the virus simulation to other diseases, disciplines and use cases.

To highlight the occurrences of the CT skills in correlation with informatics concepts we use the two-dimensional categorization system for informatics tasks from Dagienė, Sentance and Stupurienė (2017).

| | Algorithms and programming | Data, data structures and representations | Computer processes and hardware | Communication and networking | Interactions, systems and society |
|----------------------|---|--|---------------------------------|------------------------------|--|
| Abstraction | Design a model for the computer simulation and choose a fitting programming language. | Determine relevant Data for the model. | | | Determine aspects of viral diseases that are both socially relevant and computationally implementable. |
| Algorithmic thinking | Create sequences and rules to | Describe the parameters and data of a viral disease in | | | Analysis of social dynamics in the history of |

| | | | | | |
|-----------------------|--|--|--|--|--|
| | simulate a viral disease. | a computational way. | | | virus epidemics. |
| Decomposition | Programming the virus simulation by breaking it down into its subcomponents. | Determine parameter dependencies in viral diseases in order to describe their individual components. | | | |
| Evaluation | | Compare the outcomes of the virus simulation to real world data. Check if the virus simulation is fitting to real world scenarios. | Parallel processing of all agents of the virus simulation. | | Decide which measures are feasible with regard to society as well as morally and ethically acceptable. |
| Generalization | | Develop other computational simulations on the basis of the knowledge gained. | | | Comparison of different simulations and regional trends. Conclusions from different scenarios on possible future trends. |

Tab. 1: Occurring CT skills and informatics concepts in a two-dimensional categorization system (Dagienė, Sentance, Stupurienė, 2017, pp. 35-38).



Target group and prerequisites

The target group consists of prospective informatics teachers in tertiary education and their teacher educators.

Requirements

Required Pre-knowledge of prospective informatics teachers:

- Knowledge of Computational Thinking Skills (Abstraction, Decomposition, Generalization, Evaluation, Algorithmic Thinking).
- At least initial programming skills.
- Basic knowledge of algorithms and data structures.

Keywords

simulation, viral disease, StarLogo TNG, algorithmic thinking, model, generalisation



Learning Outcomes (LOs) and Assessment Methods

| Learning Outcomes | Assessment Methods |
|---|---|
| 1. (Remember) to be able to name characteristics of viral diseases | Evaluation through the participation in discussions and evaluation of the work documentation. |
| 2. (Understand) to be able to explain which CT skills are involved in creating computer simulations and how they occur. | Evaluation of the filled two-dimensional categorization matrices from Dagienė, Sentance and Stupurienė (2017). |
| 3. (Analyze) to be able to identify the relevant parameter of viral diseases to create a virus simulation for a given virus. | Evaluation of the created virus simulation. |
| 4. (Evaluate) to be able to judge the appropriateness of a simulation based on the results and real world data. | Evaluation of the refinements and revisions written in the work documentation. Evaluation of the presentations of the virus simulations. Participation in discussion after the presentations. |
| 5. (Create) to be able to create a computer simulation for viral diseases. | Assessment of the created virus simulations. |

Tab. 2: Learning Outcomes and Assessment Methods



Unit 3 - CT aspects of computer simulations

Unit 3.1 CT related to computer simulations; parameters of viral diseases

Brief description

This double session (90 min) includes research on viral diseases from a biological and medical perspective, the occurrence of CT skills in computer simulations using a concrete example, and an introduction to StarLogo TNG.

There are also two home exercises included, one before the double session and one after.

Figure 2 shows the structure of Unit 3.1:

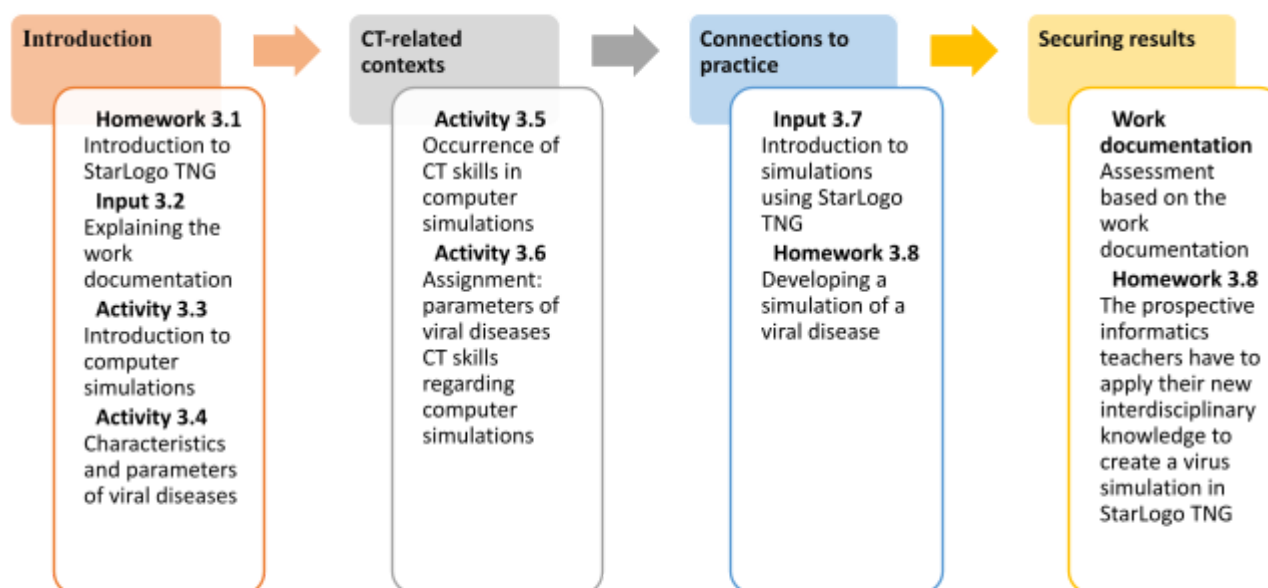

Fig. 1: Structure of unit 3.1

Detailed planning

The schedule for the first two sessions:

| Phase Time (in min) | Content | Social Form | LOs Prospective teachers should be able to ... |
|---------------------------|---|------------------|---|
| Session 1 (45 min) | | | |
| Introduction 5 | Input 3.2: Work documentation <ul style="list-style-type: none"> Explaining the template for the work documentation and its components Grouping for the upcoming group works | Frontal teaching | |
| Introduction 15 | Activity 3.3: Introduction to computer simulations | Group work | ... describe computer simulations and name their key aspects. |

| | | | |
|-------------------------------|---|------------|--|
| | Based on an example of a computer simulation, the key aspects of computer simulations are determined. | | |
| Introduction 10 | Activity 3.4: Characteristics and parameters of viral diseases <ul style="list-style-type: none"> - Searching for information about viral diseases. - Determination of characteristics of viral diseases. | Group work | ... characterize viral diseases and name their key parameters. |
| CT-related contexts 5 | Activity 3.5: CT skills regarding computer simulations <p>Based on an example presented in activity 3.3, the occurring CT skills and informatics concepts are determined and described using the two-dimensional categorization system from Dagienė, Sentance and Stupurienė (2017).</p> | Group work | ... recognize the way CT and informatics concepts occur in computer simulations. |
| CT-related contexts 10 | Activity 3.6: Assigning parameters of viral diseases to CT skills and informatics concepts <p>The prospective informatics teachers shall describe the correlation between the parameters of viral diseases and CT skills for a computer simulation using a two-dimensional matrix.</p> | Group work | ... analyze which CT skills are needed to create a virus simulation and how they are involved. |

Session 2 (45 min)

| | | | |
|-----------------------------------|--|------------------|---|
| Connections to practice 30 | Input 3.7: Introduction to simulations using StarLogo TNG <ul style="list-style-type: none"> - Presenting the fundamentals to create a multi-agent simulation with StarLogo TNG - Discussing questions from homework 3.1 - Explaining Homework 3.8 | Frontal teaching | ... recall the basics to program a virus simulation using StarLogo TNG. ... summarize the key elements to create a multi-agent simulation with StarLogo TNG. |
| Securing | Work documentation | Individual | ... recognize the gained |

| | | | |
|---------------------------|--|------------------|--|
| results 10 | Filling the graphic regarding subject content, IT content and CT skills and describing how the CT skills are involved. | work | knowledge regarding computer simulations and viral diseases. ... describe which respectively how the CT skills are involved. |
| Securing results 5 | Homework assignment Presenting the tasks of homework 3.8 | Frontal teaching | ... create a computer simulation for viral diseases. ... identify the components of the given real world problem that are incorporated in the virus simulation. |

Tab. 3: Detailed planning of Unit 1.1

Homework

Homework 3.1: In the preparation for Unit 3, the prospective informatics teachers are given a series of tasks and links to tutorials for StarLogo TNG. In this type of flipped classroom setting, they are familiarized with the programming language and development environment.

Homework 3.8: Development of a virus simulation in StarLogo TNG via a set of scaffolded tasks. The individual outcomes should include the characteristics found. In their implementations the correlating CT skills should be considered and applied.

Further details can be found in “ Units and activities”.

Unit 3.2 CT in computer simulations on the example of a virus simulation with StarLogo TNG

Brief description

The second double session (90 min) of this unit focuses on the developed virus simulations and their evaluation. The virus simulations should be finalized and presented. The presentations are followed by discussions on the implemented parameters of viral diseases and the influence of CT skills on the development.

Regarding the developed virus simulations and the interdisciplinary content of this topic, research questions and findings should be formulated.

For summary and securing results the two-dimensional assignment matrices are presented and refinings and revisings of the virus simulations will be discussed.

Figure 4 shows the structure of Unit 3.2:

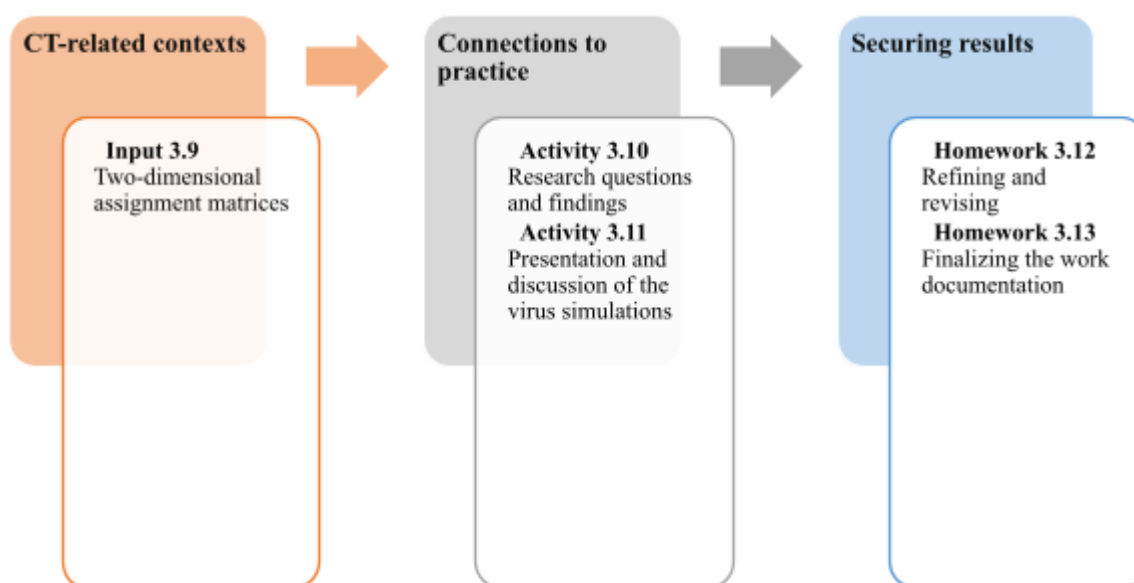

Fig. 2: Structure of Unit 3.2

Detailed planning

The schedule for the second two sessions:

| Phase Time (in min) | Content | Social Form | LOs Prospective teachers should be able to ... |
|-----------------------------------|---|-------------|---|
| Session 3 (45 min) | | | |
| CT-related contexts 10 | Input 3.9: Presentation of the assignment matrices The lecturer presents and summarizes the findings of the two-dimension assignment matrices filled in activity 3.6. | Plenum | ... recall relevant parameters of viral diseases for creating a virus simulation. ... recognize the ways CT skills are involved in computer simulations. |
| Connections to practice 15 | Activity 3.10: Finding research questions and preparing the presentations - Formulating informatics, biological, medical and/or health research questions. - Describing informatics, biological, medical and/or health findings. | Group work | ... argue what can be deduced from the virus simulation in biology and health. |
| Connections to practice 20 | Activity 3.11: Presentation and discussion of the virus simulations (Part 1) - Short presentations (about 3 - 5 mins) from each group. - Brief discussion about viral disease characteristics (subject content), CT skills and | Plenum | ... argue about the appropriateness (pros and cons) of the presented simulations. ... determine the elements of the presented simulations. |

| | | | |
|-----------------------------------|--|------------------|---|
| | informatics concepts (IT content) after every presentation. | | |
| Session 4 (45 min) | | | |
| Connections to practice 40 | Activity 3.11: Presentation and discussion (Part 2) - Short presentations (about 3 - 5 mins) from each group. - Brief discussion about viral disease characteristics (subject content), CT skills and informatics concepts (IT content) after every presentation. | Plenum | ... argue about the appropriateness (pros and cons) of the presented simulations. ... determine the elements of the presented simulations. |
| Securing results 5 | Homework assignment - Refining and revising the virus simulations. - Finalizing the work documentation | Frontal teaching | ... check if the virus simulation is appropriate to the defined parameters. |

Tab 4: Detailed planning of Unit 3.2

Homework

Homework 3.12: Every single prospective informatics teacher should refine and maybe revise their virus simulation developed in group work due to the presentations, discussions and reflections on his or her own.

The refinements should be documented but do not have to be implemented. If there are major deficiencies or bugs, these can and should be revised.

Homework 3.13: Completing and finalizing the work documentation in single work. Every single prospective informatics teacher has to upload his or her own work documentation.

Notes for single sessions: There would be no homework between the first and the second session. Homework 3.8 could start at the end of the second unit and extend to the beginning of the fourth unit.



Units and activities

1. Structure of Unit 3.1

1.1 Introduction to computer simulations and viral diseases

Homework 3.1: Introduction to StarLogo TNG

- A detailed description of Homework 3.1 can be found in [Unit3_Homework_3.1_IntroductionToStarLogoTNG.pdf](#).

- The prospective informatics teachers should become familiar with the programming language StarLogo TNG and its development environment. Therefore they get a set of scaffolded tasks and links to manuals and videos.



Duration: 60 minutes



Individual work



Unit3_Homework_3.1_IntroductionToStarLogoTNG.pdf

Input 3.2: The work documentation

- A template for the work documentation is provided as Microsoft Word document (Unit3_WorkDocumentation.docx) and PDF (Unit3_WorkDocumentation.pdf).
- The lecturer presents the template and explains how to fill it.
- The graphic regarding the subject content, the IT content and the related CT skills has to be explained, if this has not been done before.
- At the end of the input the grouping for the following group work will be made.



Duration: 7 minutes



Frontal teaching

Activity 3.3: Introduction to computer simulations

- Presentation of a computer simulation (see Appendix 1 & 2).
- Determining aspects of a computer simulation (in general).



Duration: 10 minutes



Plenum

Activity 3.4: Characteristics and parameters of viral diseases

- The prospective informatics teachers should research characteristics and parameters of viral diseases based on given resources (see Appendix 1).
- The prospective informatics teachers should decide which characteristics and parameters are relevant for a computer simulation of a viral disease



Duration: 10 minutes



Group work



Unit3_ibc-health-common-position-paper-eng.pdf

1.2 Interdisciplinary aspects of a virus simulation

Activity 3.5: CT skills regarding to computer simulations (in general)

- Based on the presented example of a computer simulation, the prospective informatics teachers shall determine and describe the occurring CT skills.
 - E.g. Abstraction: Design a computational model of the real world problem/situation, that should be simulated.
- For a more detailed description the prospective informatics teachers shall fill the two-dimensional categorization matrix from Dagienė, Sentance and Stupurienė (2017).



Duration: 10 minutes



Group work

Activity 3.6: Assigning parameters of viral diseases to CT skills and informatics concepts

- Based on the previously elaborated aspects of computer simulations and the relevant parameters of viral diseases, the CT skills for the implementation of a computer simulation will be determined.
- Presentation of a filled example of the two-dimensional assignment matrix.
- Filling the two-dimensional assignment matrix.
- The filled assignment matrices should be handed in digitally.



Duration: 10 minutes



Group work

1.3 Computer simulations with StarLogo TNG

Input 3.7: Introduction to simulations using StarLogo TNG

- The lecturer presents the basics of programming a (virus) simulation with StarLogo TNG.
- Questions that arose during the homework 3.1 can be discussed.
- If homework 3.1 should be part of the assessment plan, small tasks can be given to the prospective informatics teachers.



Duration: 20 minutes



Frontal teaching

Activity 3.8: Programming a virus simulation

- The remaining time of the first double session can be used to start working on the virus simulations with StarLogo TNG. Therefore a series of tasks are given to prospective informatics teachers (see Appendix 1).



Duration: 10 minutes



Group work



Unit3_Homework_3.8_Tasks_VirusSimulation.pdf

1.4 Securing results

The first double session focused on the occurrence of CT in computer simulations. In order to summarize the interdisciplinary as well as the computer science related aspects, the gained knowledge should be incorporated into the graphics regarding the subject content, the IT content and the CT skills.

Work documentation: Subject content, IT content and CT skills

- The prospective informatics teachers should fill the graphic of module 2, regarding the specific subject content, IT content and CT skills needed for programming a virus simulations.



Duration: 10 minutes



Individual work



Unit3_WorkDocumentation_Template.pdf

1.5 Homework assignment

- Development of a virus simulation in StarLogo TNG via a series of scaffolded tasks.
- The tasks are described in VirusSimulation_Development.pdf.



Duration: 180 minutes



Homework



Group work

2. Structure of Unit 3.2

2.1 Correlations of the interdisciplinary aspects

Input 3.10: Two-dimensional assignment matrices

- To build a reference to the last session and keep the focus on the CT skills, the two-dimensional assignment matrices are presented by the lecturer.
- The variety of relevant parameters of viral diseases for creating a virus simulation and the involved CT skills shall be presented as well as similarities and differences.



Duration: 10 minutes



Plenum

2.2 Outcomes and presentations

Activity 3.11: Research questions and findings

- Formulating informatics, biological, medical and/or health research questions.
- Describing informatics, biological, medical and/or health findings



Duration: 15 minutes



Group work

Activity 3.12: Presentation and discussion of the virus simulations

- Short presentations (about 3 - 5 mins) from each group.
- Brief discussion about viral disease characteristics (subject content), CT skills and informatics concepts (IT content) after every presentation.



Duration: 60 minutes



Plenum

2.3 Securing results

Homework 3.13

- Every single prospective informatics teacher should refine and maybe revise their virus simulation developed in group work due to the presentations, discussions and reflections.



Duration: 15 minutes



Homework



Individual work

Homework 3.14

- Completing and finalizing the work documentation.



Duration: 30 minutes



Homework



Individual work

2.4 Homework assignment

- Refining and revising the virus simulations.
- Finalizing and completing the work documentation.



Duration: 45 minutes



Homework



Individual work



Assessment requirements and assessment strategy

All assessment tasks should be handed in before the deadline set.

| Assessment task (Unit 3) | Assessment criteria and method (Unit 3) |
|------------------------------------|--|
| 1. Work documentation | The elaboration of the tasks of the work documentation can be assessed in terms of correctness, completeness and extent. |
| 2. Virus simulation & presentation | The assessment is based on the consideration of CT aspects, the implementation of characteristic parameters of viral diseases, the presentation of the virus simulation as well as the refinement and improvement plans. |

Tab. 5: Assessment requirements and assessment strategy



Learning resources



- WHO publication to viral diseases: [Unit_3_ibc-health-common-position-paper-eng.pdf](#), p. 1-3



- YouTube: Simulation of natural selection (10 min)
<https://www.youtube.com/watch?v=0ZGbIKd0XrM>

- YouTube: StarLogo TNG - Navigation and Setup Methode:
<https://www.youtube.com/watch?v=TsTkJ7eB4X0>
- YouTube: StarLogo TNG - Run-Methode and Movement:
<https://www.youtube.com/watch?v=GaLZTkMZNK4>
- YouTube: StarLogo TNG - Collision:
<https://www.youtube.com/watch?v=0Ie0LTKcLKU>
- YouTube: StarLogo TNG - Create own procedure:
<http://web.mit.edu/mitstep/webdav/How%20to%20Create%20a%20Procedure/How%20to%20Create%20a%20Procedure.pdf>
- YouTube: StarLogo TNG - Create Terrain:
<http://web.mit.edu/mitstep/webdav/How%20to%20Edit%20Levels/How%20to%20Edit%20Levels.pdf>



- Download and install Starlogo TNG:
<http://web.mit.edu/mitstep/starlogo-tng/download/index.html>



- Example of the work documentation: Unit3_WorkDocumentation_Example.pdf.



Implementation ideas

- As the focus of this module lies on CT and not on gaining programming skills, code snippets of the virus simulation that shall be edited can be given to the prospective informatics teachers.
- To reduce or increase the workload of the virus simulation, tasks can be left out or added.
- The contents of the group works can also be presented by the lecturer.



References

Dagienè, V., & Sentance, S. (2016, October). It's computational thinking! Bebras tasks in the curriculum. In *International conference on informatics in schools: Situation, evolution, and perspectives* (pp. 28-39). Springer, Cham.

Dagienè, V., Sentance, S., & Stupurienè, G. (2017). Developing a two-dimensional categorization system for educational tasks in informatics. *Informatica*, 28(1), 23-44.

Amer, A. (2017). Reflections on Bloom's Revised Taxonomy. *Electronic Journal of Research in Educational Psychology*, 4, 213-230.

Jones, C. (2010). Interdisciplinary approach-advantages, disadvantages, and the future benefits of interdisciplinary studies. *Essai*, 7(1), 26.



Additional resources

- In advance of his module, Output 2 should be processed, since Output 2 deals with the basics of Computational Thinking. In this module the knowledge of CT skills are a prerequisite.
- Rode, J. A., Weibert, A., Marshall, A., Aal, K., von Rekowski, T., El Mimouni, H., & Booker, J. (2015, September). From computational thinking to computational making. In *Proceedings of the 2015 ACM International Joint Conference on Pervasive and Ubiquitous Computing* (pp. 239-250).
- Adler, R. F., & Kim, H. (2018). Enhancing future K-8 teachers' computational thinking skills through modeling and simulations. *Education and Information Technologies*, 23(4), 1501-1514.



Appendix 1: Material for students - future teachers



- Template for the work documentation: Unit3_WorkDocumentation_Template.docx
- Tasks and references for the introduction in StarLogo TNG:
Unit3_Homework_3.1_IntroductionToStarLogoTNG.docx
- Tasks for creating a virus simulation:
Unit3_Homework_3.8_Tasks_VirusSimulation.docx



Appendix 2: Material for school teachers to be used in class



Unit 4. Robotics and sensor technology: CT in our digital world

Module *outline* is based on the work within the project “Future Teachers Education: Computational Thinking and STEAM” (TeaEdu4CT). Coordination: Prof. Valentina Dagienė, Vilnius University, Lithuania. Partners: Vienna University of Technology (Austria), CARDET (Cyprus), Tallinn University (Estonia), University of Turku (Finland), Paderborn University (Germany), CESIE (Italy), Radboud University (Netherlands), KTH Royal Institute of Technology (Sweden), Ankara University (Turkey). The project has received co-funding by the Erasmus+ Programme KA2.

TeaEdu4CT project (grant no. 2019-1-LT01-KA203-060767) 2019 license granted.





General overview and aim

Unit 4 - Robotics and sensor technology: CT in our digital world

This unit is one of two units which are focusing on interdisciplinary aspects of CT.

In this module we deal with robotics and sensor technology and mainly apply inquiry-based learning.

Students are asked to design and implement a project on climate change for a specific problem. Before that, however, a project is presented in which the prospective computer science teachers have to work out and analyse the CT skills.

Aims

- Knowing how to apply microcontrollers.
- Knowing which CT skills are required to design and implement a project.
- Promotion of creativity.
- Identification of problems related to climate change.
- Designing and implementing a project related to a problem.
- Presentation of the results and conclusion.
- Identification of CT skills in a running process.
- Classification of the CT skills using the diagram of module 2 in different layers.
- Assessment of the relevance of the CT skills in a project.

| | Algorithms and programming | Data, data structures and representations | Computer processes and hardware | Communication and networking | Interactions, systems and society |
|----------------------|---|---|---------------------------------|------------------------------|---|
| Abstraction | Identifying key elements in the problem task | Description of relevant information | | | |
| Algorithmic thinking | Implementation (planning and programming) of the projects | Preparation of the presentation including results | | | Programming using the graphical user interface at micro:bit |

| | | | | | |
|-----------------------|---|---|--|--|---|
| Decomposition | Problems must first be divided into sub-problems before a project can be designed | | | | |
| Evaluation | | Deduce conclusions from the project results and the diagram from module 2 regarding subject and IT content. | | | |
| Generalisation | | | | | The problem can be from any area, e.g. language issues; "What can be done to improve the readability of a text?". |

Tab. 1: Occurring CT skills and informatics concepts in a two-dimensional categorization system (Dagienė, Sentance, Stupurienė, 2017, pp. 35-38).



Target group and prerequisites

The target group consists of prospective informatics teachers in tertiary education and their teacher educators.

Requirements

Required Pre-knowledge of prospective informatics teachers:

- Knowledge of Computational Thinking Skills (Abstraction, Decomposition, Generalisation, Evaluation, Algorithmic Thinking, ...).
- At least initial programming skills.
- Introduction to algorithms and data structures.

Keywords

Robotics, sensor technology, climate change, microcontroller, micro:bit



Learning Outcomes (LOs) and Assessment Methods

The learning outcomes were formulated using Bloom's Taxonomy Action Verbs:

| Learning Outcomes: | Assessment Methods: |
|---|--|
| 1. (Understand) to be able to identify the CT skills in a running process | Participation in discussion (Introduction) |
| 2. (Apply) to be able to apply the CT skills in their own project | Implementation of the own project; it is checked on the basis of the presentation; discussions |
| 3. (Analyze, Evaluate) to be able to analyse and evaluate the CT skills in a running process | Participation in discussion (Introduction), evaluation of the diagram of module 2 that will be presented during the presentation |
| 4. (Create) to be able to design and develop a new project regarding a problem | Evaluation of the results of the project |

Tab. 2: Learning Outcomes and Assessment Methods



Unit 4

This unit comprises four lessons of 45 minutes each. The four lessons can either take place on 4 different dates as individual lessons or on two different dates with a double lesson of 90 minutes each. However, this unit cannot be held as a single block course on a single day because the prospective teachers have to design and implement projects as homework, which will be presented at the end of this unit. So, there is an effort of approximately 180 minutes (3h) for performing homework exercises. This unit mainly consists of discussion and practical work. A lecture is not part of this module, instead the results and experiences of the projects are presented and discussed in the plenum.

Brief description

As already mentioned, this module is more practically oriented. In the first session the CT skills will be worked out by showing a video about the implementation of a project with a microcontroller. Afterwards, the prospective teachers will work in small groups on a project to solve the problem:

What can be done to reduce heat sources in urban areas?

and implement it.

Afterwards, the project results, including which CT skills were used, will be presented and discussed.

Figure 1 shows the more detailed structure of this unit:

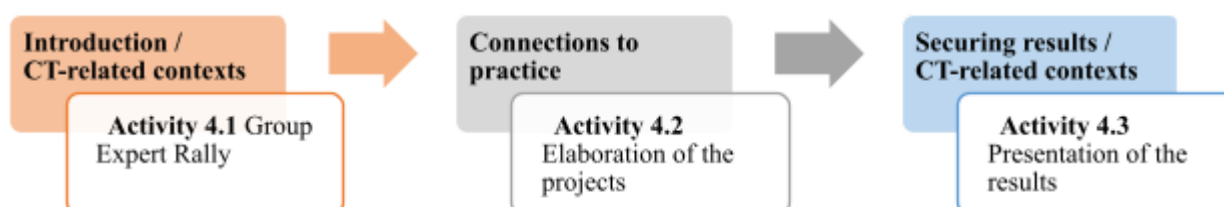

Fig. 1: Overview of unit 4

Detailed planning

| Phase Time (in min) | Content | Social Form | LOs Prospective teachers should be able to ... |
|----------------------------|--|-----------------|---|
| Session 1 (45 min) | | | |
| Introduction 5 | Grouping For every CT skill there is a group. If many students participate, the CT skills can be awarded twice. | Group work | |
| Introduction 10 | Input 4.1: Demonstration of a video concerning microcontroller A video (in the appendix) about the implementation of a project using micro:bit should be played. | Individual work | |
| Introduction 15 | Group Expert Rally Internal discussion in the own group about the following | Group work | ... recognize the CT skills during the implementation of a project. |

| | | | |
|------------------------|--|--------|--|
| | <p>questions:</p> <p><i>To what extent are the CT-skills used or not used in the implementation of the presented project?</i></p> <p><i>To what extent is your CT-skill used?</i></p> <p>Afterwards the groups should evaluate all CT skills, in how far they are relevant in this case.</p> | | <p>... evaluate how important the CT skills are in a specific situation.</p> <p>... argue why some CT skills are more relevant in a certain situation than others.</p> |
| Introduction 15 | <p>Group Expert Rally</p> <p>Based on the evaluation of the CT skills by the groups, a discussion with the whole class takes place.</p> <p>Each group has to contribute how important their CT skill is and why the other CT skills are more or less important.</p> | Plenum | <p>... argue why some CT skills are more relevant in a certain situation than others.</p> |

Session 2 (45 min)

| | | | |
|--------------------------------------|--|------------|---|
| Connections to practice 5 | <p>Grouping</p> <p>Small groups should be created for the development of projects.</p> | Group work | <p>... identify the</p> <p>... recognize that</p> |
| Connections to practice 10 | <p>1. Discussion of the organizational points*</p> <p>2. Notification of the problem:</p> <p>“What can be done to reduce heat sources in urban areas?”</p> <p>3. Presentation of the example project regarding the problem (in the appendix, Unit4_Project_ClimateChange.pdf)</p> | | |
| Connections to practice 15-20 | <p>Research, definition of the project</p> | Group work | |
| Connections to practice 10-15 | <p>If there is time left over, the first considerations regarding the implementation of the own project can be started.</p> | Group work | |

Session 3 (45 min)

| | | | |
|---|---|------------|--------------------------------------|
| Connections to practice 25-30 | Work on projects and presentations <ul style="list-style-type: none"> - Clarification of open questions - Completion of the last activities - Documentation, which CT skills are used - Preparation of the presentation | Group work | ... apply newly acquired techniques. |
| Securing results / CT-related contexts 15-20 | Presentation of the projects <ul style="list-style-type: none"> - Explanation Topic - CT-skills that have been used (using the diagram "conceptualisation" of module 2) - Results - Project schedule <p>After each presentation the following points should be discussed:</p> <ul style="list-style-type: none"> - Were the CT skills presented actually used? - Have some skills occurred but not been demonstrated? - Suggestions for improvement - Open questions | Group work | |

Session 4 (45 min)

| | | | |
|-------------------|--|------------|--|
| Phase 3 45 | Presentation of the projects: <ul style="list-style-type: none"> - CT-skills that have been used - Explanation Topic - Results - Project schedule <p>After each presentation the following points should be discussed:</p> <ul style="list-style-type: none"> - Were the CT skills presented actually used? - Have some skills occurred but not been demonstrated? - Suggestions for improvement - Open questions | Group work | ... remember the key aspects of CT in informatics. |
|-------------------|--|------------|--|

Tab. 3: Detailed planning of Unit 4

Homework

1. Implementation of the project.
2. Preparation of the presentation incl. elaboration of the CT skills according to the given graphic.

Further details can be found in “ Units and activities”.



Unit and activities

1. Structure of Unit 4

1.1 Introduction

Activity 4.1: Group Expert Rally



Duration: 45 minutes



Group Expert Rally



Unit4_Evaluation_GroupExpertRally.docx



Video: Science Experiments 03 Temperature Sensor

- <https://www.youtube.com/watch?v=pHDYsy6xyE4>

- This is a "warm-up" activity.
- The intention is to work out the CT skills right at the beginning of the unit by showing an example project (video), because they have to consider it later in their own projects as well.
- Process:
 1. **Grouping**
 - For every CT skill there is a group.
 - If many students participate, the CT skills can be awarded twice.
 2. **Demonstration of a video concerning microcontroller (micro:bit)**
 - A video about the implementation of a project using micro:bit should be played.
 - Video is listed under “Learning Resources”.
 3. **Each group gets 5 colored paper strips. (Simple A3 colored paper can be used here)**
 - Each CT skill, thus also group, is assigned a color, e.g.
 - Abstraction -> green
 - Decomposition -> blue
 - Algorithmic Thinking -> yellow
 - Evaluation -> red



- Generalization -> orange
 - The coloured paper strips are given out in maximum length.
 - The length of the paper strips should show how relevant the CT skills are in the opinion of the groups.
 - All CT skills should be written down on the blackboard or wall - side by side.
 - The paper strips from the groups (i.e. the evaluations) are then fixed underneath.
 - If a group feels that a CT skill has not occurred, the paper strip can either be left out or cut off shorter, depending on how important the group feels it is.
 - This way you can see at a glance how important the groups think about their own CT skill (by their color) and how important the other CT skills are.
 - The CT skills written on the blackboard or wall could also be written with the same colour, so that you can see immediately which CT skill has evaluated which CT skills and how.
 - The implementation takes place at point 4 (next step).
- 4. Internal discussion in the own group and evaluation of the CT skills**
- Internal discussion in the own group about the following questions:
 - *To what extent are the CT-skills used or not used in the implementation of the presented project?*
 - *To what extent is your CT-skill used?*
 - The groups have to reflect to what extent the CT skills have occurred or the relevance.
 - They have to adjust the length of the paper strips according to how relevant the CT skills are.
- 5. After the internal meetings of the groups, the evaluation of the groups takes place (*)**
- Each group goes out one after the other and fixes the paper strips under the CT skills.
- 6. Based on the evaluation of the CT skills by the groups, a discussion with the whole class takes place.**
- Each group has to contribute how important their CT skill is and why the other CT skills are more or less important.

(*) If you do not have colored papers, you can pass the evaluation sheet (in the appendix, Unit4_Evaluation_GroupExpertRally.docx) during the internal discussions of the groups and have the CT skills evaluated.

CT Reference of the project “Temperature Sensor” (graphic was taken from module 2):

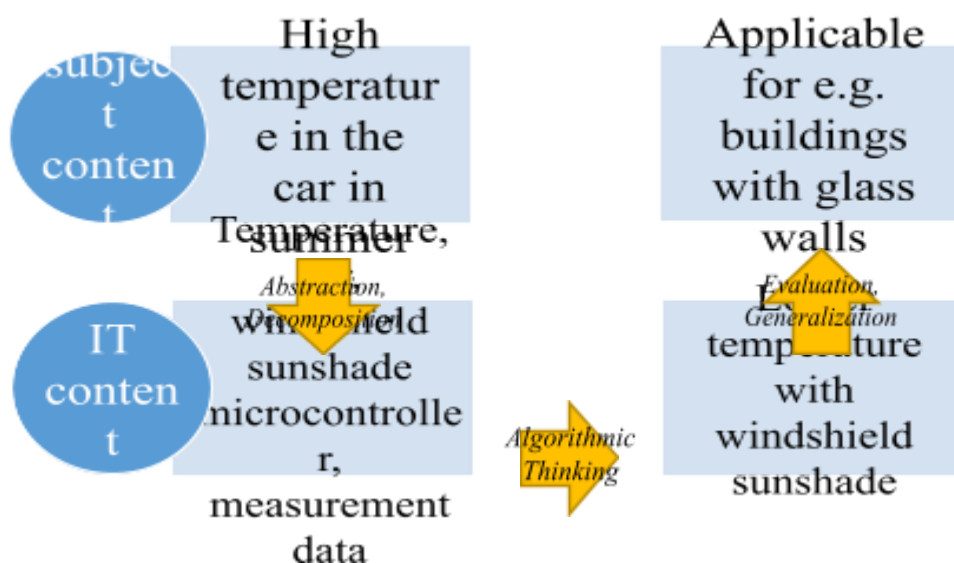

Fig. 5: Conceptualization for Example Project “Temperature Sensor”

1.2. Development of the contents

Activity 4.2 Elaboration of the projects



Duration: ~75 minutes (During the units)



Group work



Unit4_Project_ClimateChange.pdf

- This is the main work.
- Prospective teachers should consider and implement a project concerning the question "What can be done to reduce heat sources in urban areas?".
- In this case, the duration (~75 minutes) only applies to the presence time, i.e. the time they have available during the units to work on their projects.
- As homework, the prospective teachers should continue working on their projects and presentations. For more details on homework, see point **1.4. Homework assignment**.
- As a support, the teacher educator will present an example project concerning the question. (see example Unit4_Project_ClimateChange.docx).
- Working out the CT skills:
 - During the project phase, prospective teachers should also reflect on their CT skills, as well as during the introductory phase.
 - For this purpose, they will be given a diagram (of module 2 “conceptualization”) illustrating the conceptualization of the CT skills.
 - They have to fill in the diagram and present it during the presentations (1.3 Securing results).
 - The diagram “conceptualization” they have to fill in looks like this:

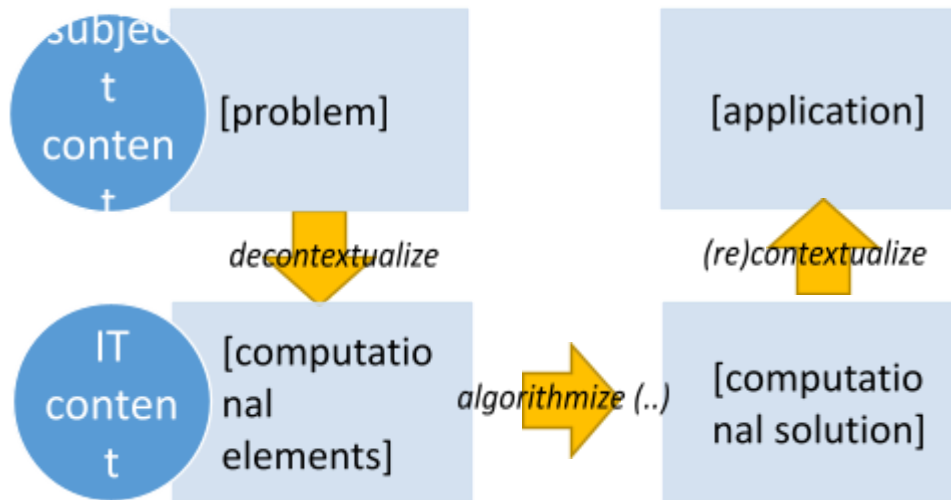

- As a support, the teacher educator will present the diagram "conceptualization" of module 2 from the example project so that the prospective teachers have a guideline:

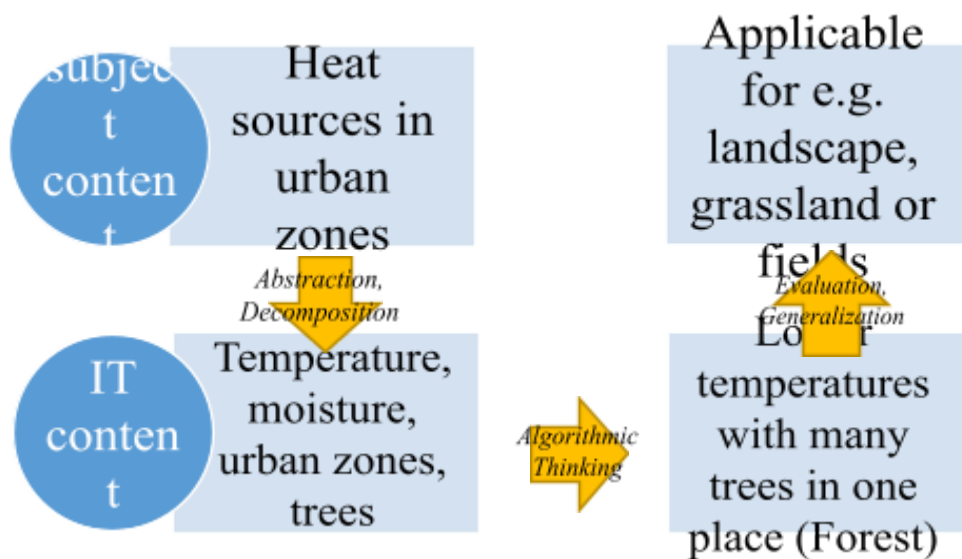

1.3. Securing results

Activity 4.3 Presentation of the results



Duration: ~45 minutes



Group presentations

- This is for summary and discussion of findings of the prospective teachers.
- Each group member must report on his or her part.
- At the end of the unit the results are presented and discussed:
 - Explanation topic

- CT-skills that have been used (using the diagram "conceptualisation" of module 2)
- Results
- Project schedule
- The intention here is that the prospective teachers themselves use the microcontroller to gain findings regarding the implementation of a project and reflect on the CT skills that are used during the project.

1.4. Homework assignment



Duration: about 195 minutes



Homework

1. Implementation of the project.
 - The project concerning the question “*What can be done to reduce heat sources in urban areas?*”, which was already defined in the presence time, is to be implemented as a homework exercise.
2. Preparation of the presentation.
 - Beginning of the preparation of the presentation incl. elaboration of the CT-skills according to the diagram of module 2.
 - The following points must be presented:
 - i. Explanation Topic
 - ii. CT-skills that have been used (using the diagram "conceptualisation" of module 2)
 - iii. Results
 - iv. Project schedule
 - After each presentation the following points should be discussed:
 - i. Were the CT skills presented actually used?
 - ii. Have some skills occurred but not been demonstrated?
 - iii. Suggestions for improvement
 - iv. Open questions



Assessment requirements and assessment strategy

All assessment tasks should be handed in before the deadline set.

| Assessment task | Assessment criteria and method |
|--|---|
| 1. Participation in Group Expert Rally | Individual assessment Each one is evaluated individually: <ul style="list-style-type: none"> - Participated - Not participated - An extra note for particularly good arguments |

| | |
|-----------------|---|
| 2. Project | <p>Group assessment</p> <p>A group of 3, for example, receives 33 points for their work. The group then suggests who should receive how many points each - depending on the “achievements” in the group, e.g. 11 points each, or - if the work was unequally distributed - in the distribution 13, 10, 10 or similar.</p> <p>The teacher educator reserves the right to give the final marks.</p> <p>However, the following points must be achieved:</p> <ul style="list-style-type: none"> - Project must be related to the task (no topic missed) - How relevant is the project / can it actually be applied in reality? - Elaboration of CT skills <ul style="list-style-type: none"> *Diagram of module 2 *How many CT skills are used? - Unambiguous results |
| 3. Presentation | <p>Individual assessment</p> <p>Each one is evaluated individually:</p> <ul style="list-style-type: none"> - Content and structure <ul style="list-style-type: none"> *What is the structure? *Is there any new information? - Visualization <ul style="list-style-type: none"> *Presentation of the results using a tool - Language <ul style="list-style-type: none"> *Is it spoken clearly and distinctly? - (Possibly body language) |

Tab. 4: Assessment requirements and assessment strategy



Learning resources



- Document for the assessment of CT skills (Introduction); Unit4_Evaluation_GroupExpertRally



- Example project to show; project_climatechange.pdf



- Science Experiments 03 Temperature Sensor
<https://www.youtube.com/watch?v=pHDYsy6xyE4>



Implementation ideas



References

Dagienè, Valentina, and Sue Sentance. "It's computational thinking! Bebras tasks in the curriculum." *International Conference on Informatics in Schools: Situation, Evolution, and Perspectives*. Springer, Cham, 2016.

Amer, Aly. "Reflections on Bloom's revised taxonomy." *Electronic Journal of Research in Educational Psychology* 4.1 (2006): 213-230.

Jones, Casey. "Interdisciplinary approach-advantages, disadvantages, and the future benefits of interdisciplinary studies." *Essai* 7.1 (2010): 26.



Additional resources

- In advance of his module, Output 2 should be processed, since Output 2 deals with the basics of Computational Thinking. In this module the knowledge of CT skills are a prerequisite.
- It might be possible to continue with Module 2 "Huffman Code" (O6 - Module 2).
- Fadel, Charles, Maya Bialik, und Bernie Trilling. *Four-Dimensional Education*, 2018.
- Papert, Seymour. *Mindstorms: children, computers, and powerful ideas*. 2nd ed. New York: Basic Books, 1993.
- Plant for the Planet. URL: <https://www.plant-for-the-planet.org/de/informieren/baeume-sind-genial-2>
- Micro:bit Extentions. URL: <https://makecode.microbit.org/extensions>



Appendix 1: Material for students - future teachers



- Example project to show; Unit4_Project_ClimateChange.pdf



- Science Experiments 03 Temperature Sensor
<https://www.youtube.com/watch?v=pHDYsy6xyE4>



Appendix 2: Material for school teachers to be used in class



- Document for the assessment of CT skills (Introduction);
Unit4_Evaluation_GroupExpertRally.docx



- Example project to show; Unit4_Project_ClimateChange.pdf



- Science Experiments 03 Temperature Sensor
<https://www.youtube.com/watch?v=pHDYsy6xyE4>